

Nadine Plus

By: burdastyle

<http://www.burdastyle.com/projects/nadine-plus>



We like our Nadine jacket so much, we wanted to make sure everyone could make it! The striking asymmetric collar is a beautiful frame for one's face, especially with the horsehair we added for extra body. The jacket's silhouette suits a variety of body types, but we wanted to take away most of the gathers for a

cleaner, more fitted look. Try this jacket in a light wool for your perfect Spring jacket.

Materials

wool, silk lining, interfacing, horsehair, buttons, shoulder pads, shoulder headings

Step 4 — *OPTIONAL PATTERN ADJUSTMENT STEP*

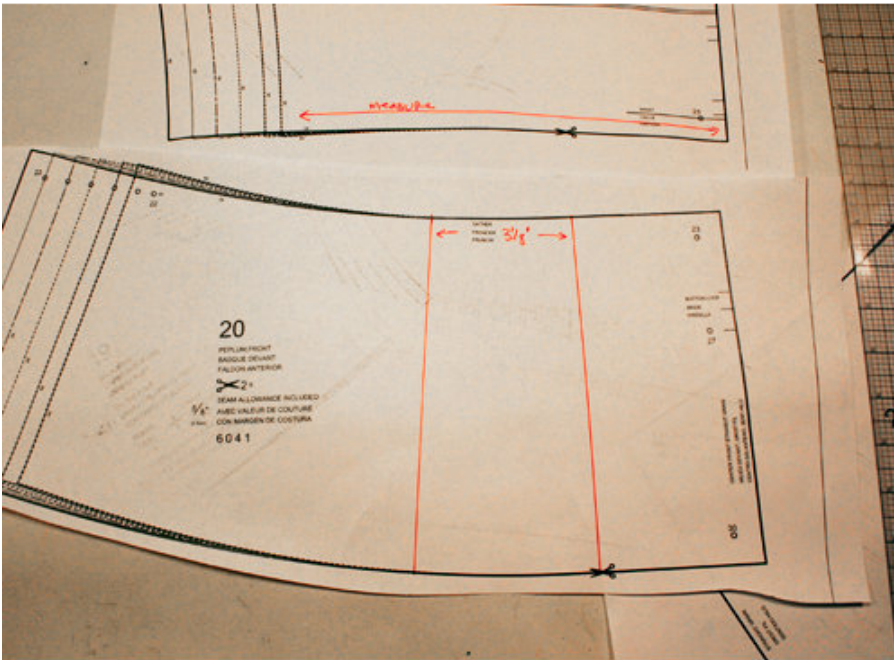

*Steps 4-10 are showing how to adjust the printed pattern to make a cleaner look without gathers at the peplum (for the look pictured in the project images)

Front Peplum: Measure the bottom edge of the front bodice piece. For size 44, it's $10 \frac{3}{8}$ ". Now, we want the top edge of the front peplum to measure $10 \frac{3}{8}$ " also. The top edge of the front peplum measures $13 \frac{1}{2}$ ". $13 \frac{1}{2} - 10 \frac{3}{8} = 3 \frac{1}{8}$ ". Take away the excess from the center of the pattern piece, marking as shown. The straight lines can be slightly farther apart than $3 \frac{1}{8}$ " at the bottom edge.

Step 5 — *OPTIONAL PATTERN ADJUSTMENT STEP*

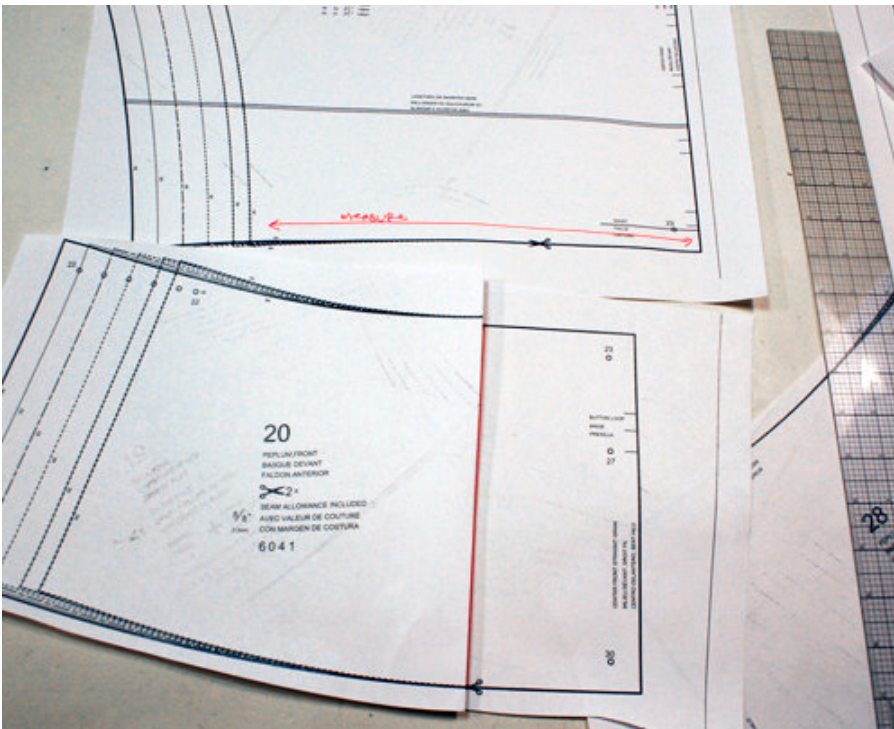

Fold one line to meet the other, thus eliminating the excess, and tape down. Repeat, eliminating 3 1/8", from the corresponding lining piece.

Step 6 — *OPTIONAL PATTERN ADJUSTMENT STEP*

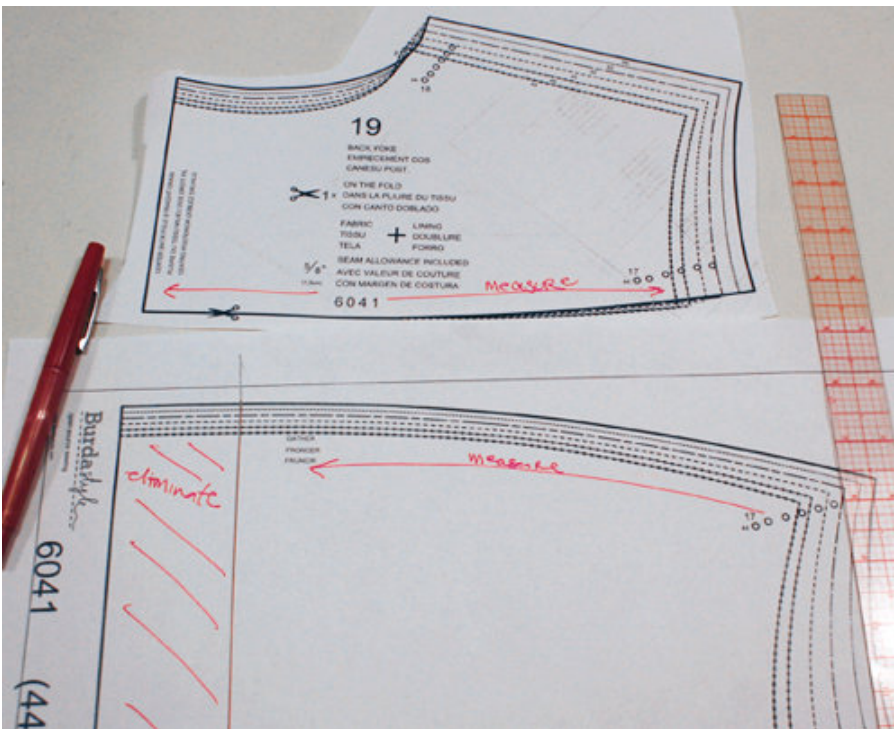

Back Yoke: Measure the bottom edge the back yoke piece. On the back bodice piece, measure in from the armhole edge toward center back, making a mark to match the measurement of the yoke piece. Mark, and

draw a line parallel to center back. This is your new â' Cut on Foldâ' line. Repeat for the corresponding lining piece.

Step 7 — *OPTIONAL PATTERN ADJUSTMENT STEP*

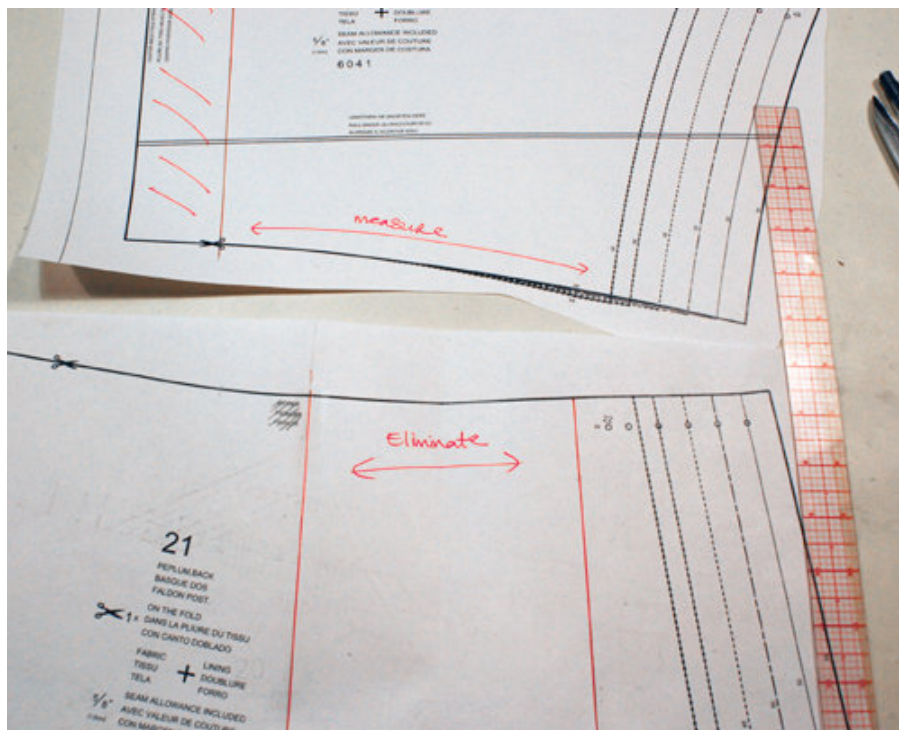

Back Peplum: Measure the bottom edge of back bodice piece, now that the excess has been taken out. Repeat Steps 1-2 for the back peplum, both self and lining.

Step 8 — *OPTIONAL PATTERN ADJUSTMENT STEP*

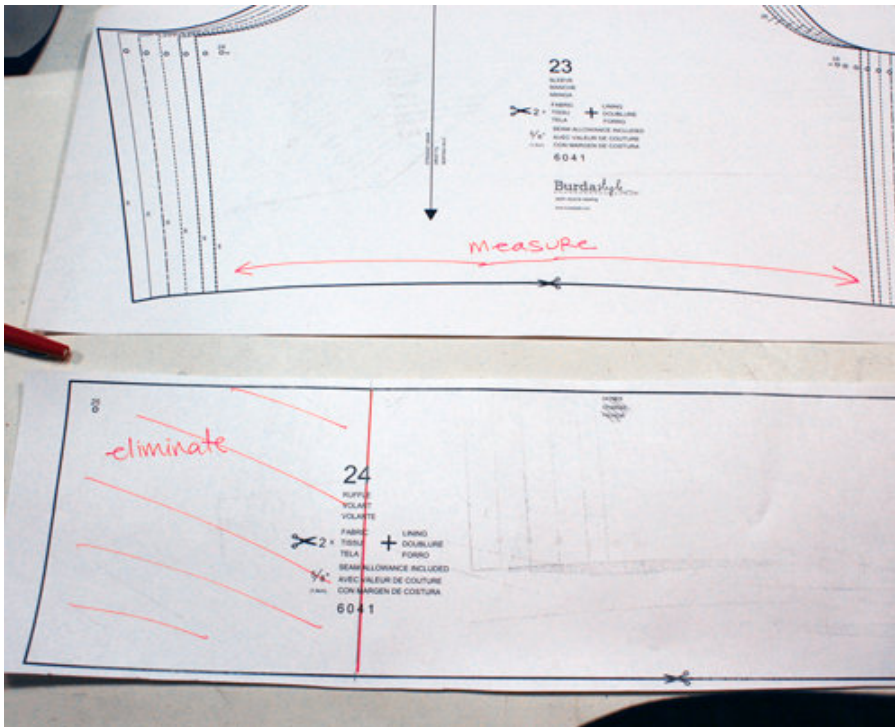

Sleeve Ruffle: Now, you know the drill. Repeat for sleeve cuff, both self and lining.

Step 9 — *OPTIONAL PATTERN ADJUSTMENT STEP*

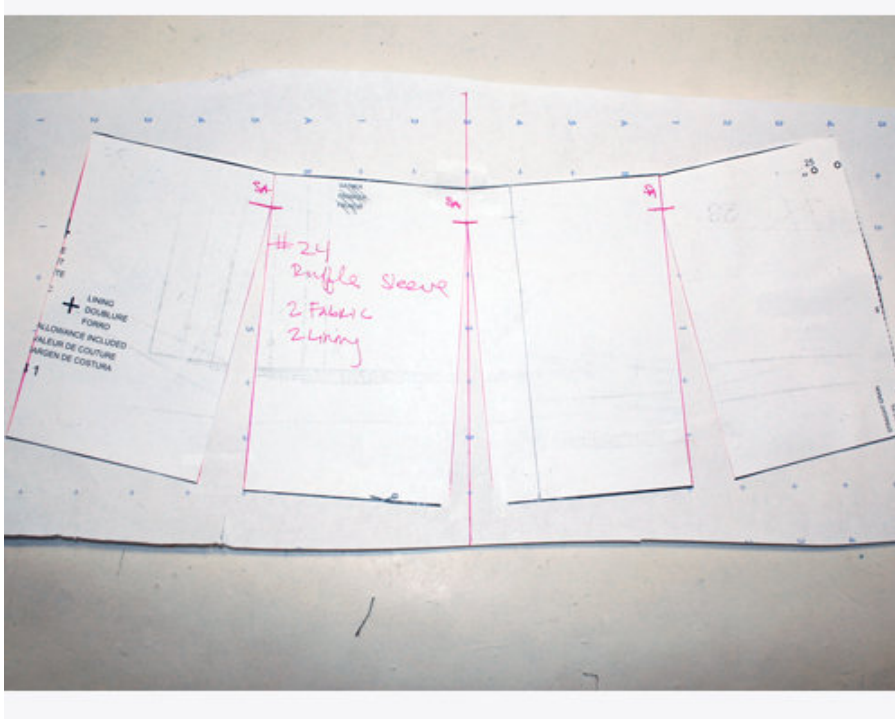

Now, we slash and spread the sleeve cuff to give a bell shape. If you donâ’ t, youâ’ ll have a straight cuff. Draw three straight lines, roughly dividing the cuff into 4 equal parts. Mark the seam allowance at the top edge, and cut to, but not through, that point, starting from the bottom of the pattern piece. Then, fro the top of

the pattern piece, cut to, but not through, the seam allowance point. Your pattern piece should be barely attached, so this point works as a pivot point. Repeat for the other marked lines. Tape down to a piece of paper, and spread about 1â' at each slash line. Use your French curve to blend the bottom edge. Repeat for lining.

Step 10 — *OPTIONAL PATTERN ADJUSTMENT STEP*



Your pattern work is done! Go ahead and sew it up, and enjoy your spiffy new jacket.

Step 1

**burda Download-Pattern
6041 – Instructions**



mittel

normal weit

burda sizes		55 ins / 140 cm											
		32	34	36	38	40	42	44	46	48	50	52	54
Jacket	yds	1 1/2	1 3/4	1 3/4	1 3/4	1 3/4	1 3/4	1 3/4	1 3/4	1 3/4	1 3/4	1 3/4	1 3/4
	m	1.30	1.35	1.35	1.40	1.40	1.40	1.45	1.45	1.45	1.50	1.50	1.50
Lining	yds	1 1/2	1 1/2	1 1/2	1 1/2	1 1/2	1 1/2	1 1/2	1 1/2	1 1/2	1 1/2	1 1/2	1 1/2
	m	1.40	1.45	1.45	1.50	1.50	1.50	1.55	1.55	1.55	1.60	1.60	1.60

→ with nap

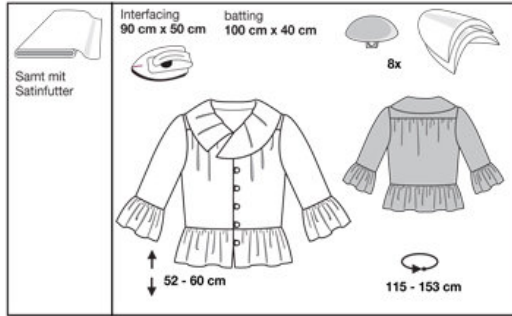

Patternpieces:

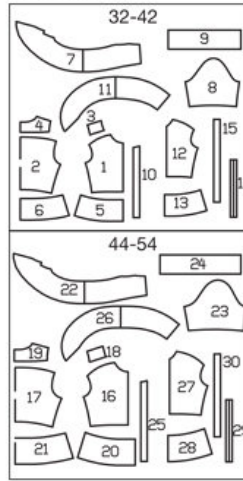

PATTERN

Sizes 16 to 26 (EU 44 to 54)

- 16 Front piece 2x
- 17 Back piece 1x
- 18 Front yoke 2x
- 19 Back yoke 1x
- 20 Front peplum 2x
- 21 Back peplum 1x
- 22 Top collar 1x
- 23 Sleeve 2x
- 24 Sleeve ruffle 2x
- 25 Front facing 2x
- Lining pieces:
- 26 Under collar 1x
- 27 Front piece 2x
- 28 Front peplum 2x
- 29 Lower flap 1x
- 30 Loops 1x

Fabrics: Lightweight wool with satin lining

Step 2

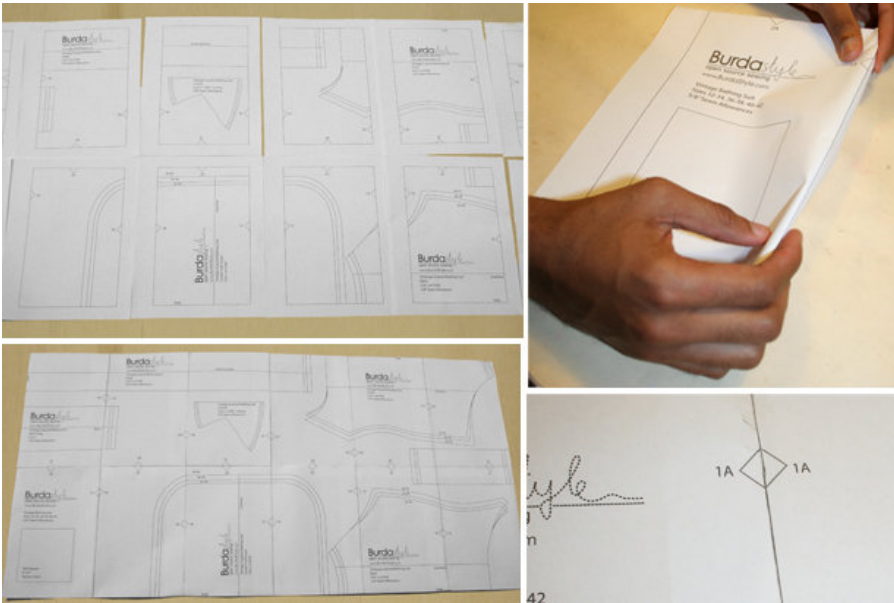

The patterns can be printed out at the copy shop. If you decide to print them at home, follow the instructions: Paper cut for ANSI A (German DIN A4) prints: For sizes 16 to 26 (EU 44 to 54), the patterns are printed out on 42 sheets with a thin frame. Wait until all sheets are printed out. Arrange the sheets so that they fit together (see additional page with the overview of the prints). Fold the single sheets on the upper and right edge along the thin frame lines. Begin with the left lower sheet and then tape the frame lines together precisely.

Step 3

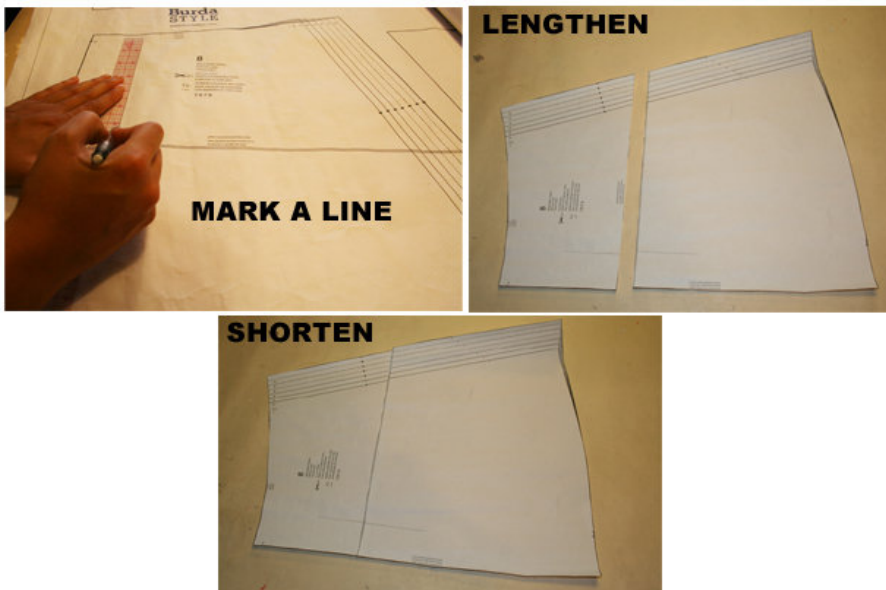

ADJUST PATTERN SIZES

Select your size according to the Burda-dimension table: dresses, blouses, jackets and coats according to the bust size, trousers and skirts according to the hip width. Change the pattern to fit your measurements if they deviate from the Burda-size chart.

Cut out the pattern pieces according to your size. Sizes 16 to 26 (EU 44 to 54): pattern pieces 16 to 30.

Refer to our 'Adjust patterns for mixed sizes' technique

LENGTHENING OR SHORTENING THE PATTERN PIECES Our pattern is calculated for a height of 5' 6" (168 cm). If you are taller or shorter, you can adjust the pattern pieces along the lines marked "lengthen or shorten here". This way the proper fit is maintained. Always adjust all pattern pieces along the same line to the same degree.

How to lengthen and shorten pattern pieces: Cut the pattern pieces along the marked lines

To lengthen, slide the two halves of the pattern piece as far apart as necessary.

To shorten, overlap the two halves of the pattern piece as far as necessary. Blend the side edges.

Step 11

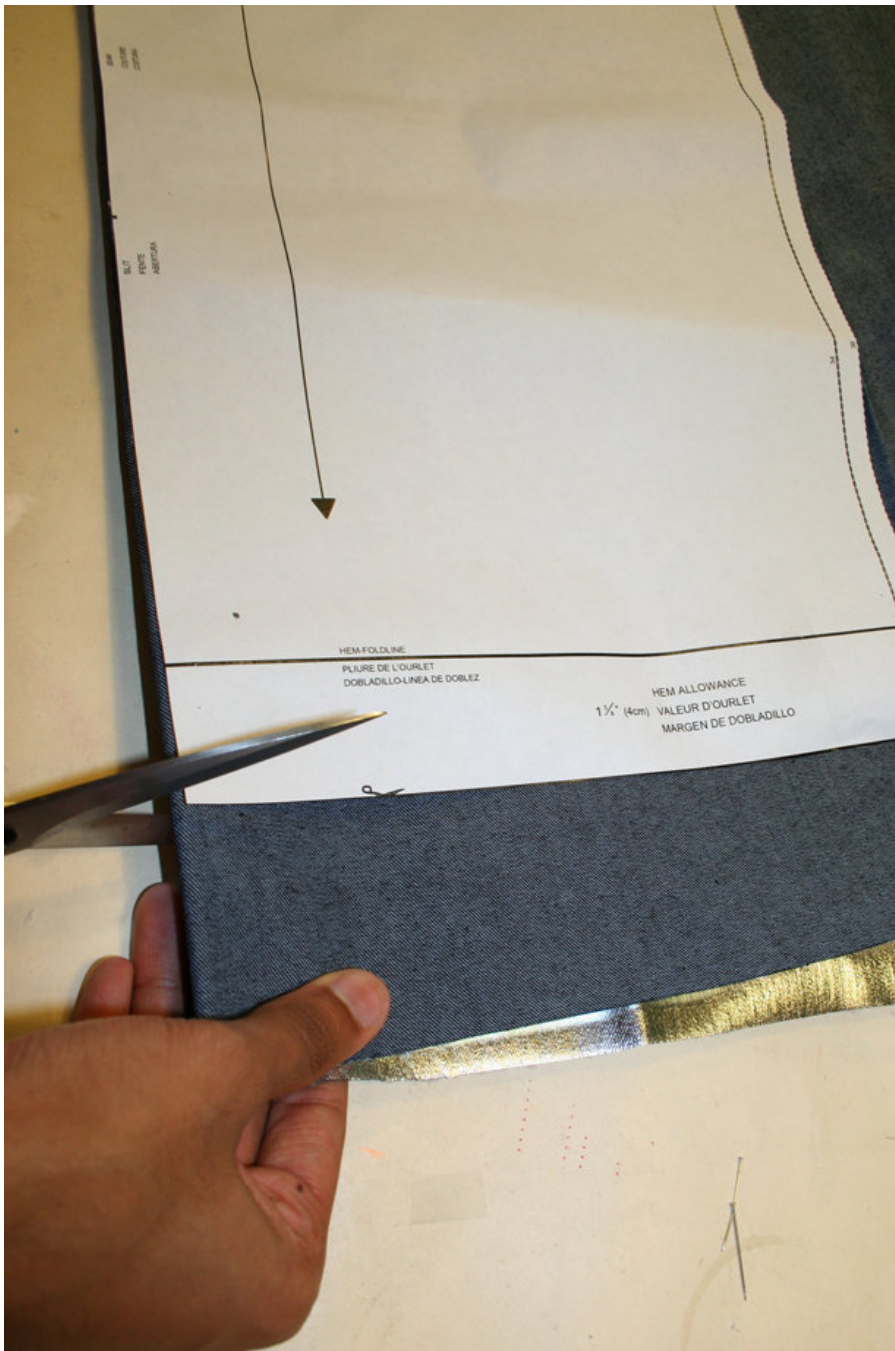

CUTTING OUT FOLD (â’ â’ â’ â’) means: Cut on the fold, the fold being the center of the pattern piece, but never a cut edge or seam. The piece should be cut double, with the fold line forming the center line. Pattern pieces are outlined with a broken line in the cutting diagrams are placed face down on the fabric. The cutting diagrams on the pattern sheet show how the pattern pieces should be placed on the fabric.

The cutting diagrams show the placement of the pattern on the fabric. For a single layer of fabric, the pattern pieces are pinned to the right side. For double layers of fabric, the right sides are facing and the pattern pieces are pinned to the wrong side. The pattern pieces that are shown extending over the fold of the fabric in the cutting diagram should be cut last from a single layer of fabric. Important: Position the collar pieces on a single layer of fabric, on the fabricâ’ s right side, and with the labeled side of the pattern facing up.

Step 12

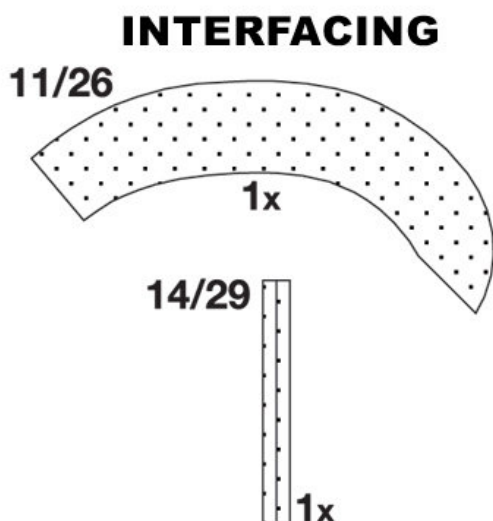

SEAM AND HEMLINE ALLOWANCES are included:

1" (4 cm) for the hemline and 5/8" (1.5 cm) for all edges and stitches. Using BURDA copying paper, transfer the lines and signs of the pattern onto the wrong fabric side. Instructions can be found in the packaging.

LINING

Sizes 16 to 26 (EU 44 to 54), cut the lining pieces according to the pattern pieces 17, 18, 19, 21, 23, 24 and 26 to 30 of the cutting diagram.

INTERFACING / BATTING

Cut out the INTERFACING according to the picture and press onto the wrong fabric side.

Cut out light BATTING according to pattern piece 22 and pin onto the left top collar. Pin the edges.

SEWING

While sewing, the right sides of the fabric are facing. Transfer all lines of the pattern onto the right side of the fabric using basting stitches.

Step 13

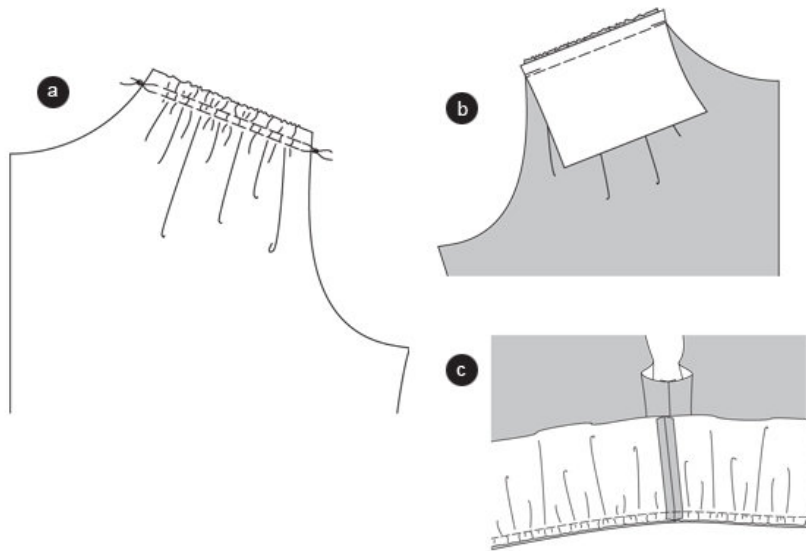

JACKET

Front and back yoke

Double stitch the front pieces narrowly using basting stitches. Tighten the bobbin threads so that the length of the front piece equals the length of yoke edge. Knot threads. Distribute the width equally (a) (This is only if using original pattern without adjustment).

Pin the yokes on the front pieces, right sides facing (seam 1/16) and stitch. Trim allowances, neaten and press inside the yokes (b).

Stitch the BACK YOKE onto the back piece (seam 1/17) according to the text and image 1 and 2.

SHOULDER AND SIDE SEAMS

Position the front and back pieces together, right sides facing. Pin shoulder (seam 3/18) and side (4/19) seams. Stitch seams. Press allowances apart.

PEPLUM

Position the front and back peplums together, right sides facing. Stitch SIDE SEAMS (seam 7/22). Press allowances apart. Double stitch the top edge of the peplum narrowly and tighten the bobbin threads to the width of the front and back piece. Knot threads. Distribute the width equally. (This is only if using original pattern without adjustment)

Pin the peplum on the bottom jacket edge, right sides facing (seam 8/23), side seams meet. Stitch. Trim allowances and press to the top ©.

Step 14

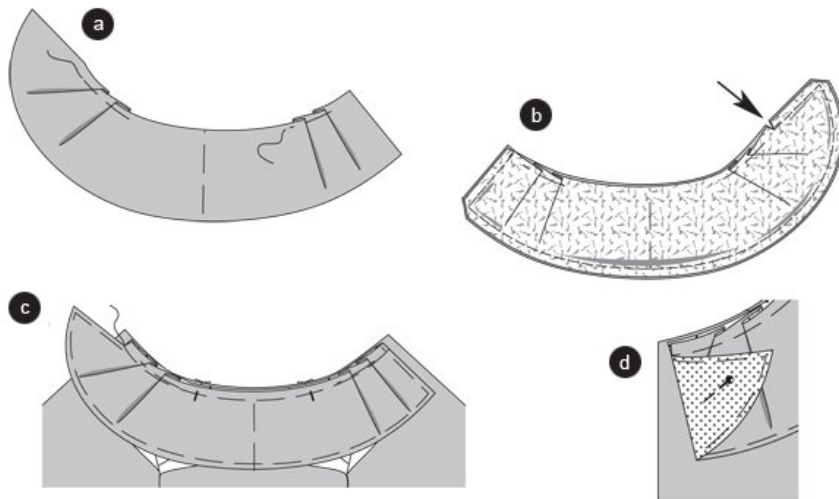

COLLAR

From the right fabric side, fold the pleats along the top collar in position (follow arrow), then pin (a).

Pin the top and under collar together, right sides facing. The top collar is slightly bigger. Pin the edges together according to the picture and stitch, ending left of the cross line. Snip in the allowances close to the stitch line (arrow), according to the picture. Trim allowances and cut the corners at a slant. Turn the collar, pin edges and press (b).

Pin the collar on the neckline, the centers meet (seam 6/21). The cross lines meet the shoulder seams ©. The under collar faces the jacket. Turn the LEFT collar corner, according to the image, and pin so that it won't be enclosed while stitching (d).

Step 15

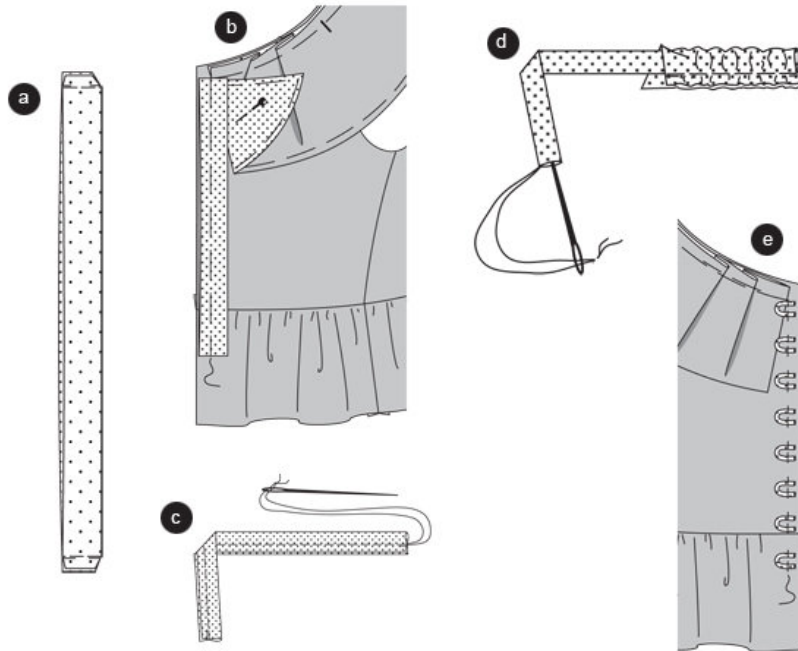

UNDERLAY

Fold the underlay along the fold line, right sides facing. Stitch the narrow edge. Trim allowance. Turn the underlay, pin edges and press. Pin the open edges together (a).

Pin the underlay on the left edge of the front piece (seam 12/27); the bottom edge meets the cross line on the peplum (b).

LOOPS

The loops are marked on the front piece according to size 4 (EU 32). The bottom loop is marked at the same spot for all sizes. Mark the spot for the top loop for all sizes, other than size 4, at the neckline edge. Space out the other loops equally.

Fold the strips for the loops lengthwise, right sides facing. Stitch 0.7 cm wide along the fold line. Trim allowances. Thread a needle and knot the threads ©. Push the needle, the eye of the needle ahead, through the channel (d). Cut the strip into 8 equal pieces.

Fold the loops and pin onto the marked cross lines on the right front edge according to the picture. The loops have to be slightly bigger than the matching button (e).

Step 16

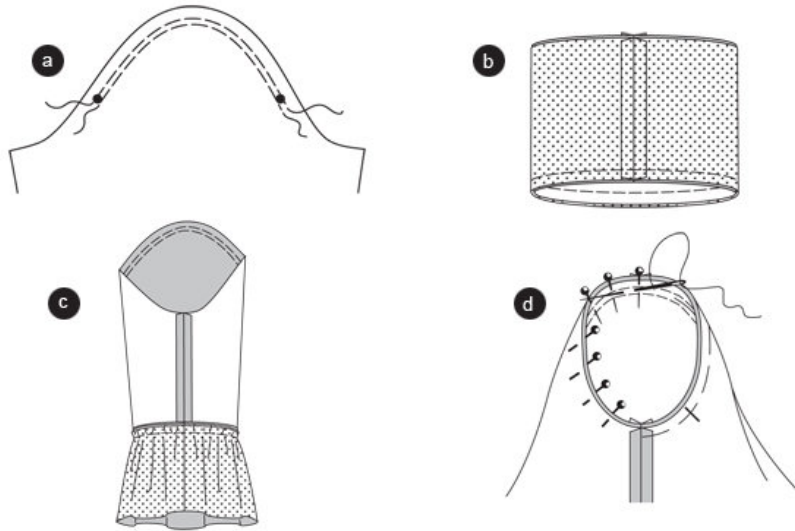

SLEEVES

Double stitch the sleeve caps from * to * narrowly using basting stitches. Fold the sleeves lengthwise, right sides facing. Stitch SLEEVE SEAMS (seam 9/24). Press allowances apart (a).

SLEEVE RUFFLES (This is only if using original pattern without adjustment)

Fold the ruffles (fabric and lining) to a circle (10/25). Press allowances apart.

Position the lining and fabric ruffles together, right sides facing. Stitch the bottom edges together. The seams meet. Turn the ruffles inside out. Pin the edges and press. Pin the top edges together. Double stitch narrowly using basting stitches. Tighten the bobbin threads so that the length of the ruffles equals the width of the sleeve (b).

Pin the ruffle on the bottom sleeve edge, right sides facing. The seams meet. Stitch. Trim allowances and press inside the sleeve ©.

APPLY SLEEVE

Double stitch the sleeve caps narrowly using basting stitches. Tighten the bobbin threads and distribute the width equally.

Apply the sleeve cap to the armhole, right sides facing. When applying, 4 points are important for the right fit: the cross lines 11/26 of the sleeve and the front piece have to meet. The inner sleeve seam has to meet the side seam. The cross line of the sleeve cap has to meet the shoulder seam. The eased width has to be distributed in a way that does not pucker or create pleats. Pin the sleeve from the sleeve side and stitch. Trim allowances and press inside the sleeve (d).

Apply the **SHOULDER PADS**. Stitch the shoulder pads on the allowances of shoulder seam and armhole seam.

Stitch the seams of the **LINING** pieces as done to the jacket. Same seam numbers meet. **IMPORTANT:** Leave one side seam open so that the lining can be turned inside out. Secure seam ends. Fold the bottom sleeve edges inside and press. Apply the sleeves to the lining piece.

Step 17

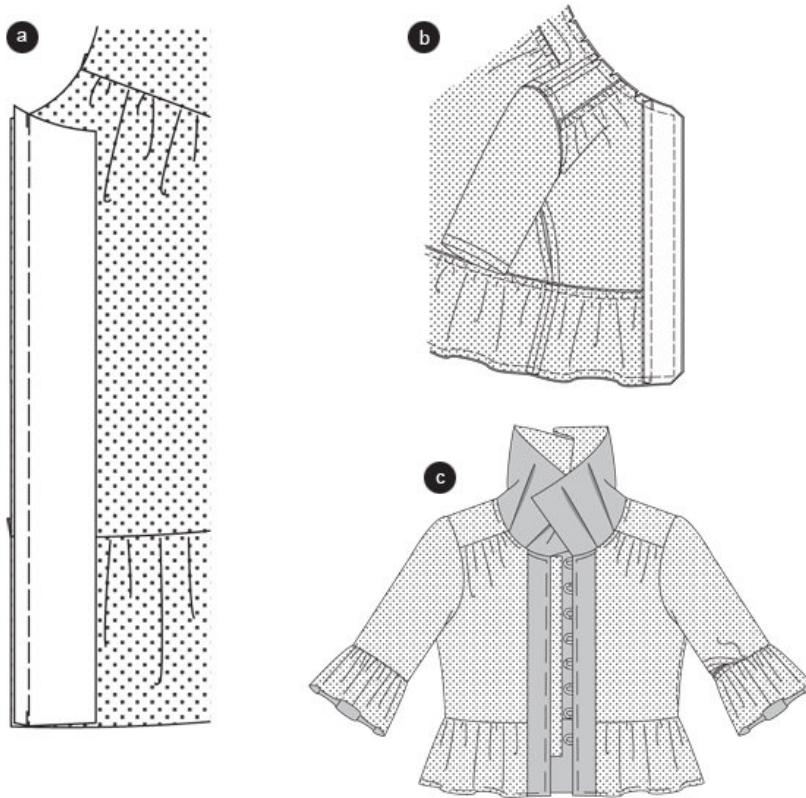

FRONT FACING

Stitch the front facings on the lining front pieces (seam 14/29), right sides facing. Press the allowances inside the lining (a).

Pin the facings and lining in the jacket, right sides facing. The seams meet. Pin the neckline edges, front and bottom edges together (15/30) and stitch. Trim allowances, cut the corners at a slant and snip in the curves. Turn the jacket inside out. Pin the edges and press (b).

Position the lining inside the jacket. The seams meet. Stitch the bottom edge of the lining sleeve onto the seam line of the sleeve ruffle. Topstitch the open lining edge narrowly. Apply **BUTTONS** onto the left front edge. The buttons need to be slightly smaller than the loops ©.

BurdaStyle

Nadine Plus