

# Esther

By: burdastyle

<http://www.burdastyle.com/projects/esther>

---



Combine Esther with anything, from a black dress to some pants or a little mini skirt. Made out of a knit bought by the yard, it is not hard to assemble. Just make sure to use a sewing needle with a round tip (for knits) in order not to break any threads while sewing.

## Materials

Knit, Rib

---

## Step 1

## burda Download-Pattern Jacket 8027 - Instructions



very easy

semi-fitted

Sizes	US Eur.	59 ins / 150 cm							
		10 36	12 38	14 40	16 42	18 44	20 46	22 48	
	ys	2 1/4	2 1/4	2 1/4	2 1/4	2 1/4	2 1/4	3	
	m	2.35	2.40	2.45	2.50	2.55	2.60	2.70	

\* without nap

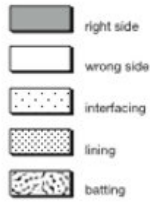
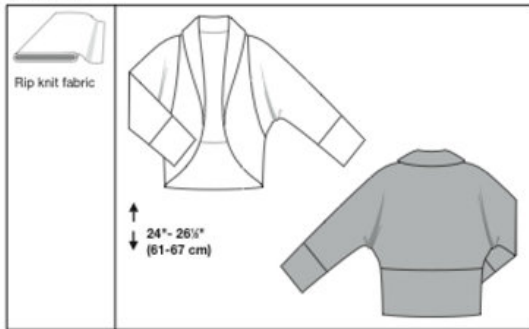

Pattern pieces:

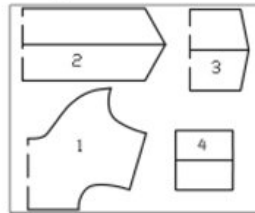

### Pattern Pieces

- 1 Jacket Front Piece 1x
- 2 Placket 1x
- 3 Back Placket 1x
- 4 Sleeve Placket 2x

## Step 2



To print the patterns out at home, follow the instructions:

Paper cut for ANSI A (German DIN A4) prints:

The patterns are printed out on 35 sheets with a thin frame. Wait until all sheets are printed out. Arrange the sheets so that they fit together (see additional page with the overview of the prints). Fold the single sheets on the upper and right edge along the thin frame lines. Begin with the left lower sheet and then tape the frame lines together precisely.

## Step 3

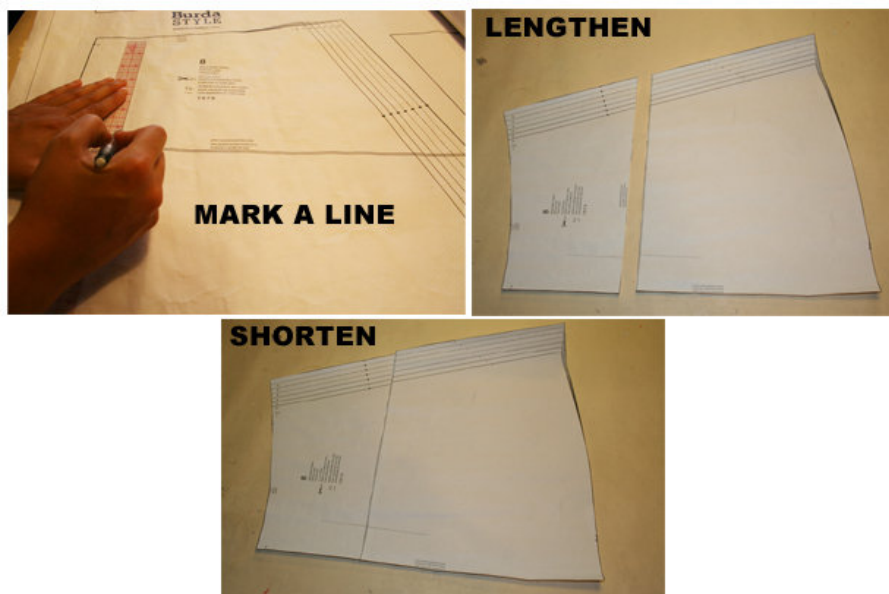

### ADJUST PATTERN SIZES

Select your size according to the Burda-dimension table: dresses, blouses, jackets and coats according to the bust size, trousers and skirts according to the hip width. Change the pattern to fit your measurements if they deviate from the Burda-size chart. Cut out the pattern according to your size.

Refer to our “Adjust patterns for mixed sizes” technique

### LENGTHENING OR SHORTENING THE PATTERN PIECES

Our pattern is calculated for a height of 5’6” (168 cm). If you are taller or shorter, you can adjust the pattern pieces along the lines marked “lengthen or shorten here”. This way the proper fit is maintained. Always adjust all pattern pieces along the same line to the same degree.

How to lengthen and shorten pattern pieces:

Cut the pattern pieces along the marked lines

To lengthen, slide the two halves of the pattern piece as far apart as necessary.

To shorten, overlap the two halves of the pattern piece as far as necessary. Blend the side edges.

---

## Step 4

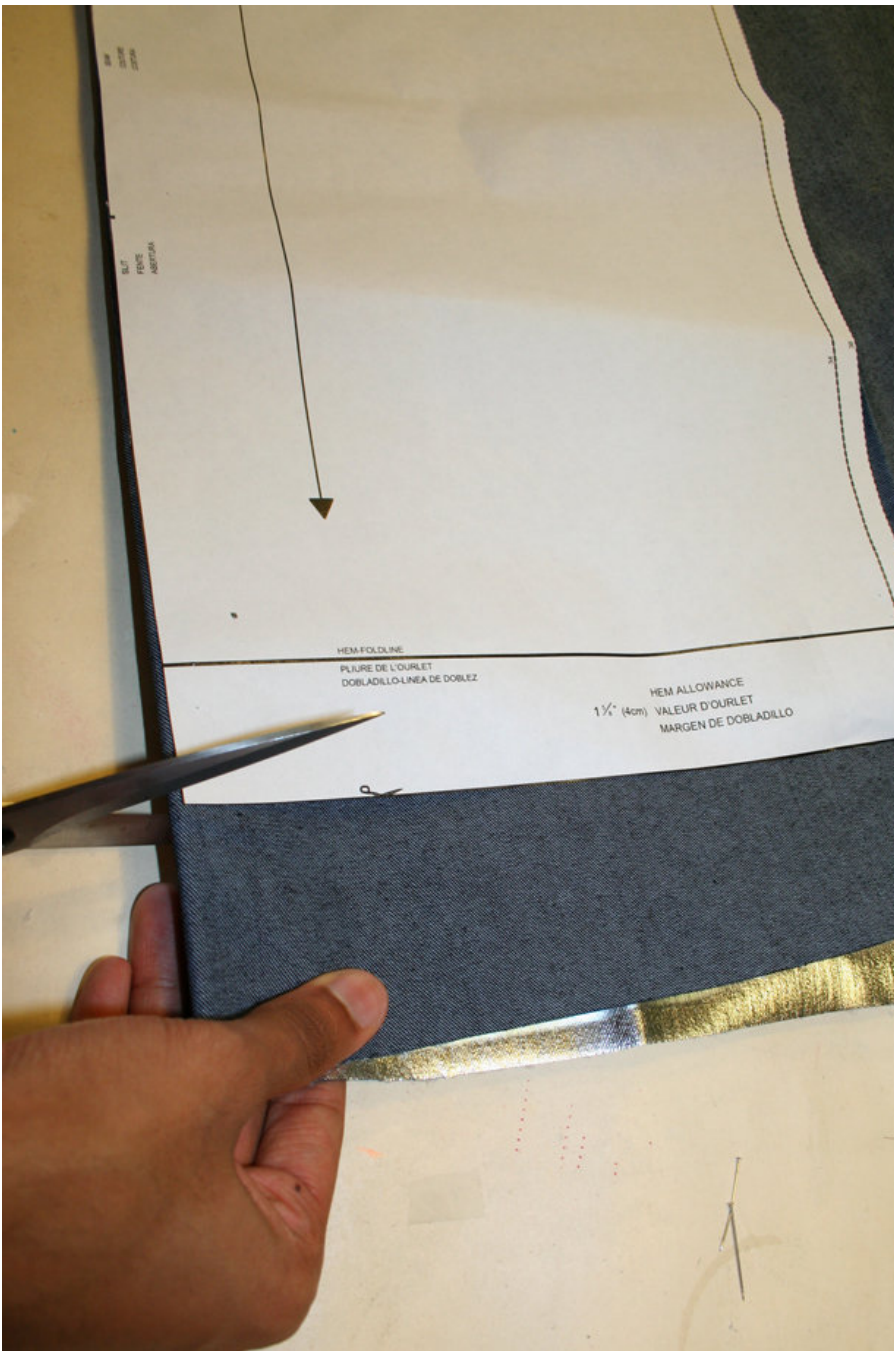

## CUTTING OUT

FOLD ( ) means: Cut on the fold, the fold being the center of the pattern piece, but never a cut edge or seam. The piece should be cut double, with the fold line forming the center line. Pattern pieces that are outlined with a broken line in the cutting diagrams are to be placed face down on the fabric. The cutting diagrams on the pattern sheet show how the pattern pieces should be placed on the fabric.

The cutting diagrams show the placement of the pattern on the fabric.

For a single layer of fabric, the pattern pieces are pinned to the right side. For double layers of fabric, the right sides are facing and the pattern pieces are pinned to the wrong side. The pattern pieces that are shown extending over the fold of the fabric in the cutting diagram should be cut last from a single layer of fabric .

## Step 5

SEAM AND HEMLINE ALLOWANCES are included on an average: 5/8" (1.5 cm) for all edges and stitches. Using BURDA copying paper, transfer the lines and signs of the pattern onto the wrong side of the fabric. Instructions can be found in the packaging.

### Sewing

While sewing, the right sides of the fabric are facing.

Transfer all lines of the pattern onto the right side of the fabric using basting stitches.

### Instructions on how to work with knit fabrics

Debaste the seam allowances with an overlock-machine or the overlock stitch of your sewing machine.

To maintain the stretchiness of the fabric, stitch the seams with an elastic stitch or with a narrow zigzag stitch. Make sure that the thread tension of the sewing machine is not set too high.

---

## Step 6

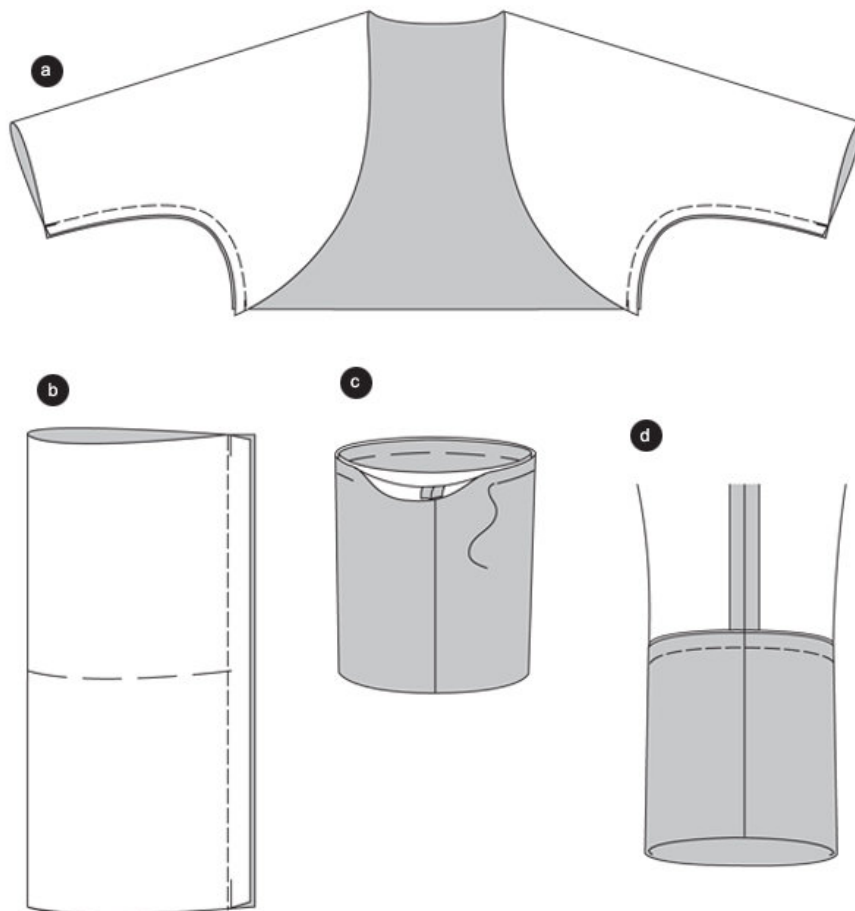

### Jacket

#### Side and Bottom Sleeve Seams

Fold the jacket piece at the marked shoulder, right side inside. Pin the side and bottom sleeve seam (Seam Number 1) and stitch. De-baste seam allowances and finish them, iron. (a)

## Sleeve Plackets

Fold the placket, right side inside. Pin seam (Seam Number 2) and stitch. Fold apart and iron seam allowances. (b)

Fold the placket at the WRAP LINE, wrong side inside. Pin open edges onto each other ©

Pin placket right sides facing onto the lower sleeve edge (Seam Number 3), seams are meeting. Stitch. Debaste seam allowances and iron to top. (d)

---

## Step 7

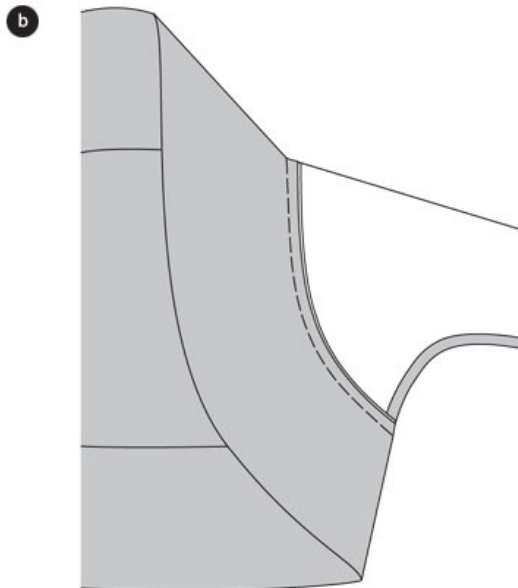
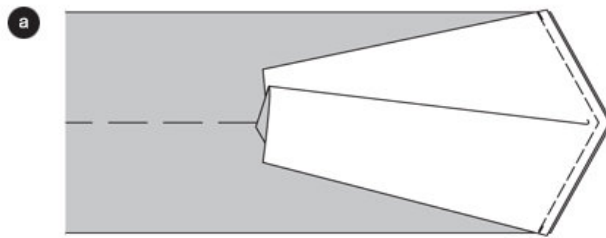

## Placket

Place back placket right sides facing onto the placket, pin side seams (Seam Number 4) and stitch. Finish the seam allowances coming from the edge going To the wrap line. Fold placket in half at the WRAP LINE, wrong side inside. Pin open edges onto each other. (a)

Place placket right sides facing and middle on middle onto the outer jacket Edge (Seam Number 5), side seams are meeting. The horizontal lines 6 meet Marked shoulder lines. Pin placket, holding the placket in place at the front Piece and arm line. Stitch placket with elastic stitch or with flat zigzag stitches. Debaste seam allowances and iron jacket. (b)

---

Esther