

# Nora Plus

By: burdastyle

<http://www.burdastyle.com/projects/nora-plus>

---



This is the plus size variation on the gown that Nora wore to the Bambi Awards. After the reaction to the original Nora dress, it was obvious there was no use making you wait while we sewed it up, we had to give you the pattern now! Though the photos are the same, the pattern is sized differently. The underskirt peaks

out from center front and at the hem, the embroidered detail frames the face as fit for queen, and the curved seaming adds extra couture touch. Just in time for Prom season, we can't wait to see your creations.

## Materials

silk shantung, embroidered ribbon, silk charmeuse, horsehair braid, hooks and eyes

## Step 1

### burda Download-Pattern 6047 - Instructions

burda sizes		55 ins / 140 cm													
		34	36	38	40	42	44	46	48	50	52	54	56	58	60
I	yds	4 1/4	5	5 1/4	5 1/2	5 3/4	6	6 1/4	6 1/2	6 3/4	7	7 1/4	7 1/2	7 3/4	8
	m	4,40	4,45	4,80	5,20	5,35	5,60	5,95	6,30	6,45	6,70	7,05	7,40	7,55	7,80
II	yds	2 1/4	3	3 1/4	3 1/2	3 3/4	4	4 1/4	4 1/2	4 3/4	5	5 1/4	5 1/2	5 3/4	6
	m	2,40	2,50	2,65	2,70	2,85	3,00	3,15	3,30	3,45	3,60	3,75	3,90	4,05	4,20
Lining	yds	3 1/2	3 1/2	3 1/2	3 1/2	3 1/2	3 1/2	3 1/2	3 1/2	3 1/2	3 1/2	3 1/2	3 1/2	3 1/2	3 1/2
	m	3,00	3,10	3,20	3,20	3,20	3,20	3,20	3,20	3,20	3,20	3,20	3,20	3,20	3,20

●●●● average  
fitted

→ with nap

★ without nap

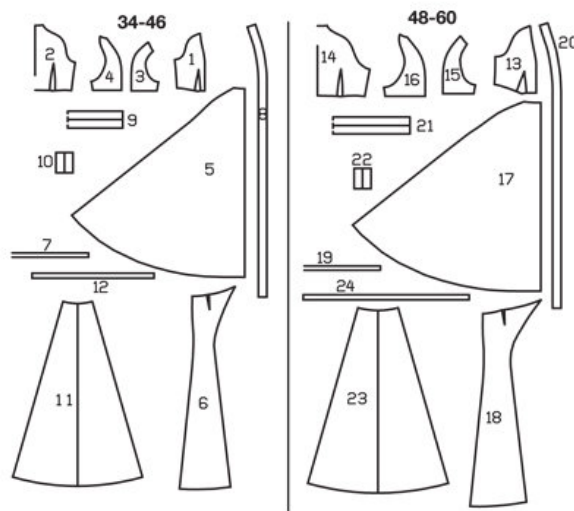
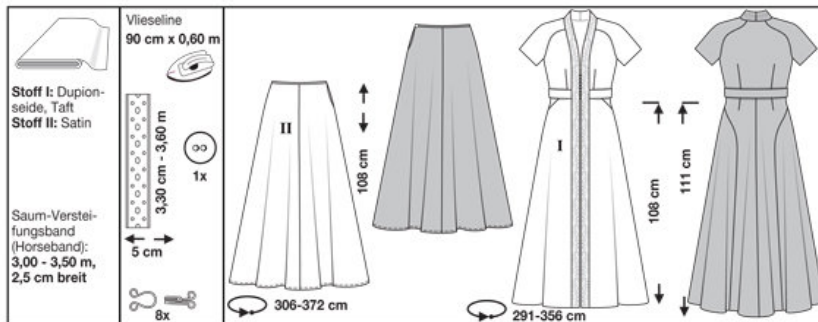

Sizes 2 to 14 (EU 34 to 46)

DRESS:

- 1 Front piece 2x
- 2 Back piece 1x
- 3 Front sleeve 2x
- 4 Back sleeve 2x
- 5 Front skirt panel 2x

6 Back skirt panel 2x  
7 Hemline facing 1x  
(bias strips)  
8 Placket 4x  
9 Belt 1x  
10 Underlay 1x

PETTICOAT:

11 Front & back skirt  
panels 4x  
12 Strips for waistband 1x

Sizes 16 to 28 (EU 48 to 60)

DRESS:

13 Front piece 2x  
14 Back piece 1x  
15 Front sleeve 2x  
16 Back sleeve 2x  
17 Front skirt panel 2x  
18 Back skirt panel 2x  
19 Hemline facing 1x

(bias strips)

20 Placket 4x  
21 Belt 1x  
22 Underlay 1x

PETTICOAT:

23 Front & back skirt  
panels 4x  
24 Strips for waistband 1x

Fabric I: Dupioni silk, taffeta Fabric II: Satin

Hemline stiffening strip (horsehair braid):

9â' 1â' to 11â' 6â' (3.00 to 3.50 m long), 1â' (2.5 cm wide)

---

## Step 2



The patterns can be printed out at the copy shop. If you decide to print them at home, follow the instructions: Paper cut for ANSI A (German DIN A4) prints: The patterns are printed out with a thin frame on 64 sheets (sizes 2 to 14 / EU 34 to 46) and 81 sheets (sizes 16 to 28 / EU 48 to 60). Wait until all sheets are printed out. Arrange the sheets so that they fit together (see additional page with the overview of the prints). Fold the single sheets on the upper and right edge along the thin frame lines. Begin with the left lower sheet and then tape the frame lines together precisely.

### Step 3

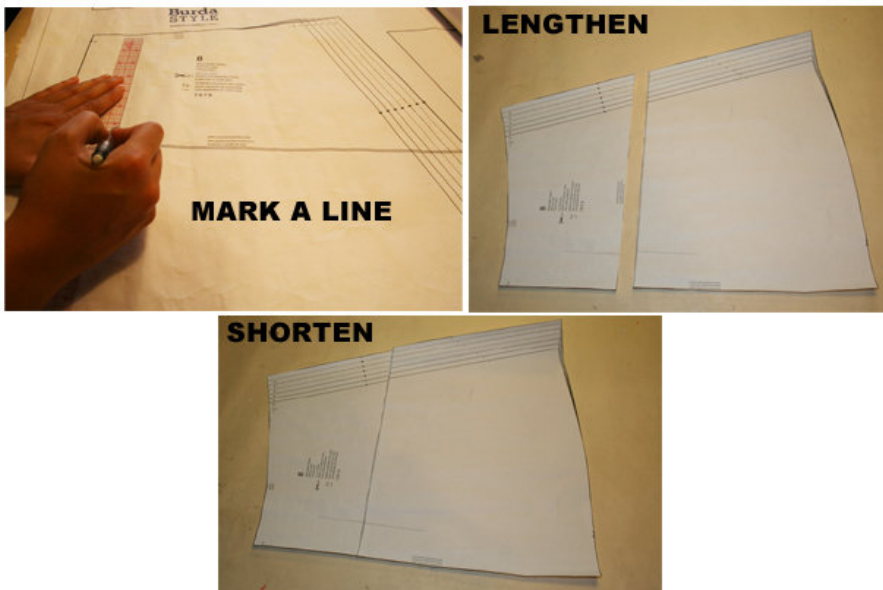

#### ADJUST PATTERN SIZES

Select your size according to the Burda-dimension table: dresses, blouses, jackets and coats according to the bust size, trousers and skirts according to the hip width. Change the pattern to fit your measurements if they deviate from the Burda-size chart.

Cut out the pattern pieces according to your size.

Sizes 2 to 14 (EU 34 to 46): Pattern pieces 1 to 12

Sizes 16 to 28 (EU 48 to 60): Pattern pieces 13 to 24

Refer to our 'Adjust patterns for mixed sizes' technique

#### LENGTHENING OR SHORTENING THE PATTERN PIECES

Our pattern is calculated for a height of 5' 6" (168 cm). If you are taller or shorter, you can adjust the pattern pieces along the lines marked "lengthen or shorten here". This way the proper fit is maintained.

Always adjust all pattern pieces along the same line to the same degree.

How to lengthen and shorten pattern pieces:

Cut the pattern pieces along the marked lines

To lengthen, slide the two halves of the pattern piece as far apart as necessary.

To shorten, overlap the two halves of the pattern piece as far as necessary. Blend the side edges.

---

## Step 4

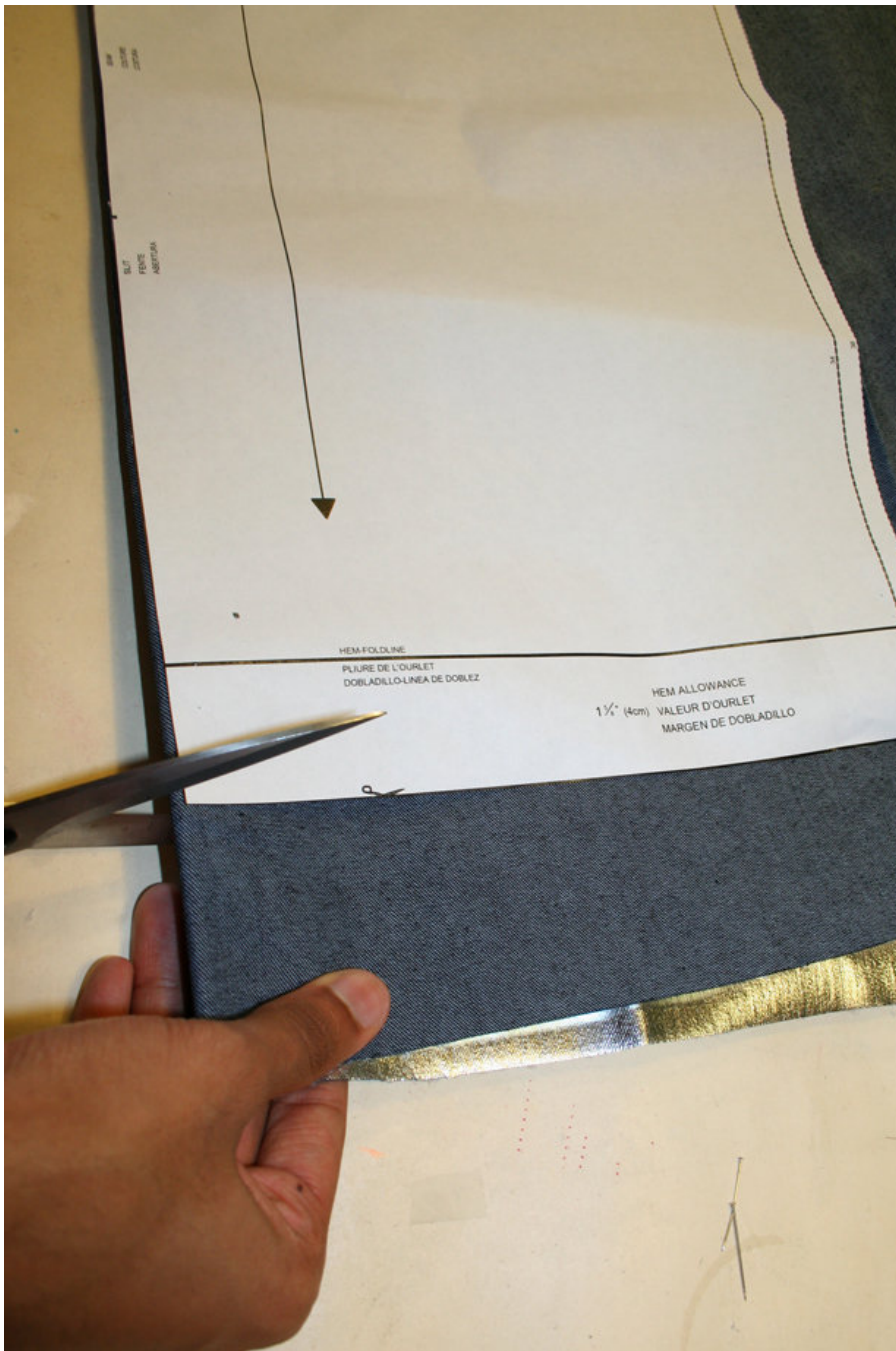

## CUTTING OUT

FOLD ( ) means: Cut on the fold, the fold being the center of the pattern piece, but never a cut edge or seam. The piece should be cut double, with the fold line forming the center line. Pattern pieces that are outlined with a broken line in the cutting diagrams are placed face down on the fabric. The cutting diagrams on the pattern sheet show how the pattern pieces should be placed on the fabric.

The cutting diagrams show the placement of the pattern on the fabric.

For a single layer of fabric, the pattern pieces are pinned to the right side. For double layers of fabric, the right sides are facing and the pattern pieces are pinned to the wrong side. The pattern pieces that are shown extending over the fold of the fabric in the cutting diagram should be cut last from a single layer of fabric.

**IMPORTANT:** To cut mirror-image pairs (skirt panels, sleeves, front pieces, etc.) cut from a single layer of fabric, place the labeled side of the pattern facing up to cut the first piece of the pair. To cut the second piece of the pair, place the labeled side of the pattern facing down.

**Fabric I:** Cut pieces 1 to 10 and pieces 13 to 22 for the dress from fabric I. Extend the bias strip (pieces 7 and 19) for the hemline by marking the length of the pattern onto the fabric until the full length is achieved (see cutting diagrams)

**Fabric II:** Cut pieces 11, 12, 23 and 24 for the petticoat from fabric II.

---

## Step 5

**SEAM AND HEMLINE ALLOWANCES** are included:

1 1/2" (3 cm) for the sleeve hem and 5/8" (1.5 cm) for all edges and stitches. Using BURDA copying paper, transfer the lines and signs of the pattern onto the left fabric side. Instructions can be found in the packaging.

### LINING

Cut the lining pieces according to the cutting diagram and press it on the wrong side of the fabric.

### INTERFACING

Sizes 2 to 14 (EU 34 to 46):

Cut pattern pieces 1 to 6

Sizes 16 to 28 (EU 48 to 60):

Cut pattern pieces 13 to 18 according to the cutting diagram.

### SEWING

While sewing, the right sides of the fabric are facing.

Transfer all lines of the pattern onto the right side of the fabric using basting stitches. The seam numbers (e.g. 1/9) show how the pieces are sewn together. The first number (1/9) stands for sizes 2 to 14 (EU 34 to 46) and the second number (1/9) stands for sizes 16 to 28 (EU 48 to 60).

---

## Step 6

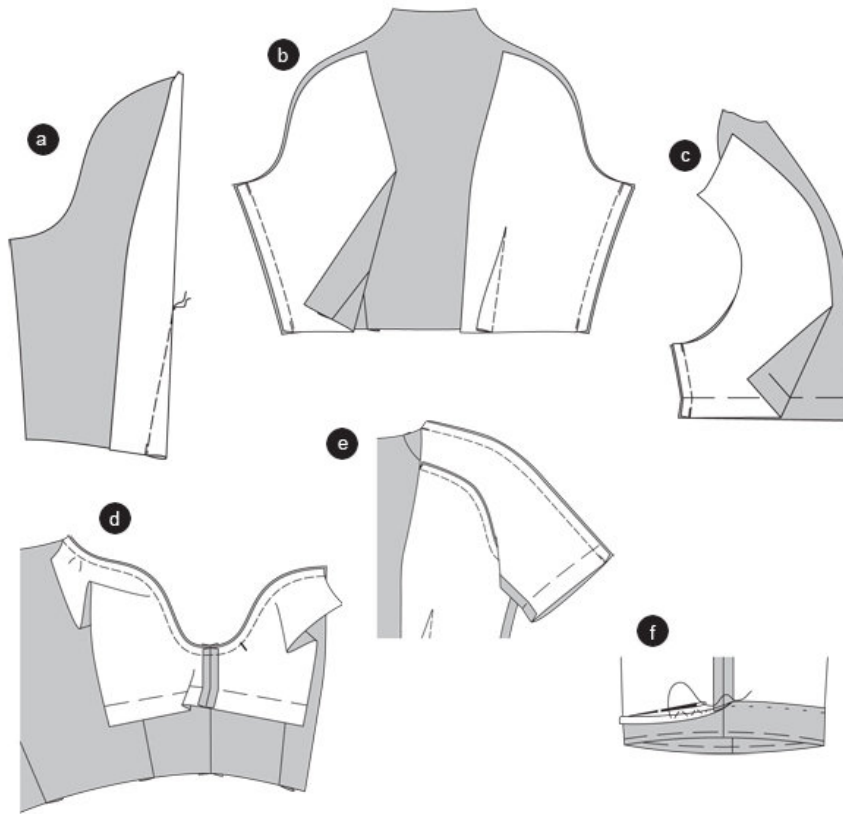

## BODICE

### Darts

Pin the darts on the front and back pieces and stitch to a point. Knot threads. Press the darts to the center of front and back (a). The image shows the front piece.

### SIDE PIECES

Position the front and back pieces together. Pin side seams (seam 1/9) and stitch. Press allowances apart (b).

### SLEEVES

Position the front and back sleeve together, right sides facing. Pin the bottom sleeve seam (seam 2/10) and stitch. Press allowances apart (c).

Pin the sleeve on the armhole, right sides facing and the sleeve seam meeting the side seam. Cross lines 4/12 of front sleeve and front piece meet. The seam 3/11 of back sleeve and back piece meet. Pin the sleeve and stitch. Trim allowances and press inside the sleeve (d).

### UPPER SLEEVE SEAMS

Position the front and back piece of the sleeve together, right sides facing. Pin the outer sleeve seam (seam 5/13). At the same time gather the shoulder part of the back piece of the sleeve, from neckline to \*. Stitch. Trim allowances and press apart (e).

### SLEEVE HEMLINE

Turn the seam allowance inside and pin, press and stitch by hand (f).

## Step 7

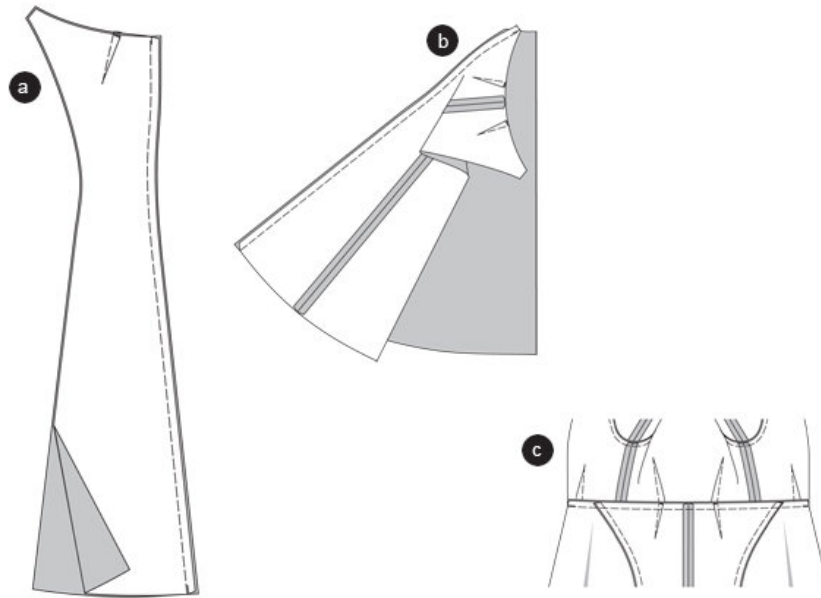

### SKIRT

Along the back skirt panels, stitch the darts to a point and press toward the center back.

Position the skirt panels together, right sides facing. Stitch the center seam. Press the allowances apart (a).

### SIDE SEAMS

Position the front and back pieces of the skirt panels together, right sides facing. Pin the side seams (seam 6/14) and stitch. Press the allowances into the front skirt panel (b).

### STITCH THE SKIRT ON THE BODICE

Position the skirt panels on the bodice piece, right sides facing; the center back seams meeting the bodice center seam (seam 7/15). The back darts meet. Pin the seam and stitch. Press the allowances into the bodice ©.

---

## Step 8

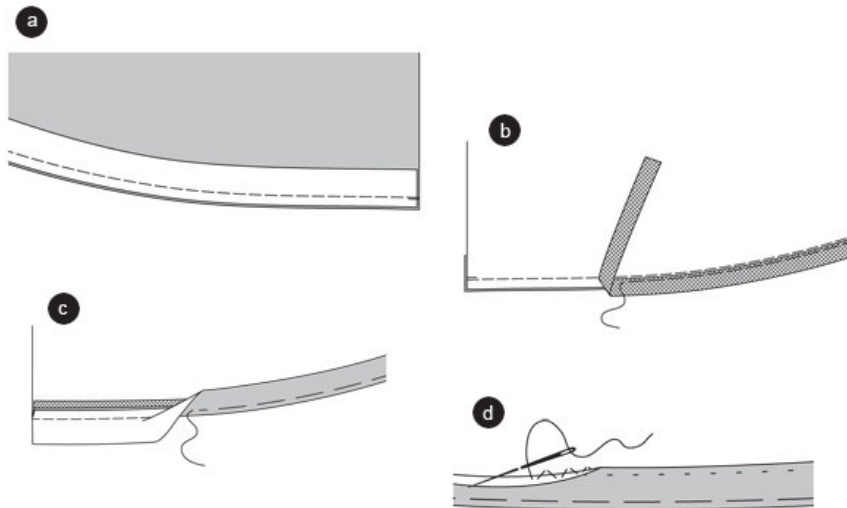

### HEMLINE WITH STIFFENING HORSEHAIR BRAID

Stitch the bias strips for the hemline facing together, as one long strip

Pin the bias strips on the hemline edge, right sides facing. Stitch. Trim allowances (a).

Pin the stiffening braid on the seam allowance (wrong side of the dress) and stitch using basting stitches (b).

Fold the bias strips to the inside of the dress. At the same time, the horsehair braid turns up and will be enclosed between dress and bias strip ©.

Sew the bias strips by hand (d).

## Step 9

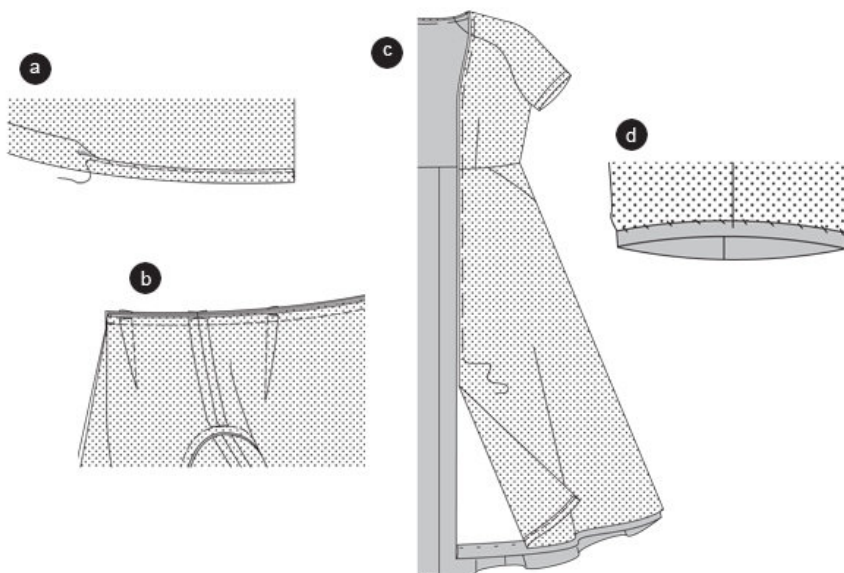

## LINING

Stitch the lining pieces together into a dress. Apply sleeves. Fold the allowances along the bottom sleeve edge  $1\frac{1}{2}$ " (1.5 cm) inside.

Fold the lining hemline  $1\frac{1}{2}$ " (3 cm) inside and press. Fold again  $1\frac{1}{2}$ " (1.5 cm) and stitch. The lining dress will be  $1\frac{1}{2}$ " (1.5 cm) shorter than the fabric dress. Attach lining skirt to lining bodice (a).

The waist seams of dress and lining meet, wrong sides facing. The other seams and darts of lining and dress meet as well, wrong sides facing. Pin together the allowances of dress and lining, along the waist, and stitch. Turn the tops of dress and lining (b).

Move the lining piece over the dress, wrong sides facing. The seams of dress and lining meet. Pin the front lining edges and neckline edges onto the dress ©.

Move the lining sleeves over the dress sleeves and pin. Slightly push up the lining edge and sew it by hand on the sleeve seam allowance (d).

---

## Step 10

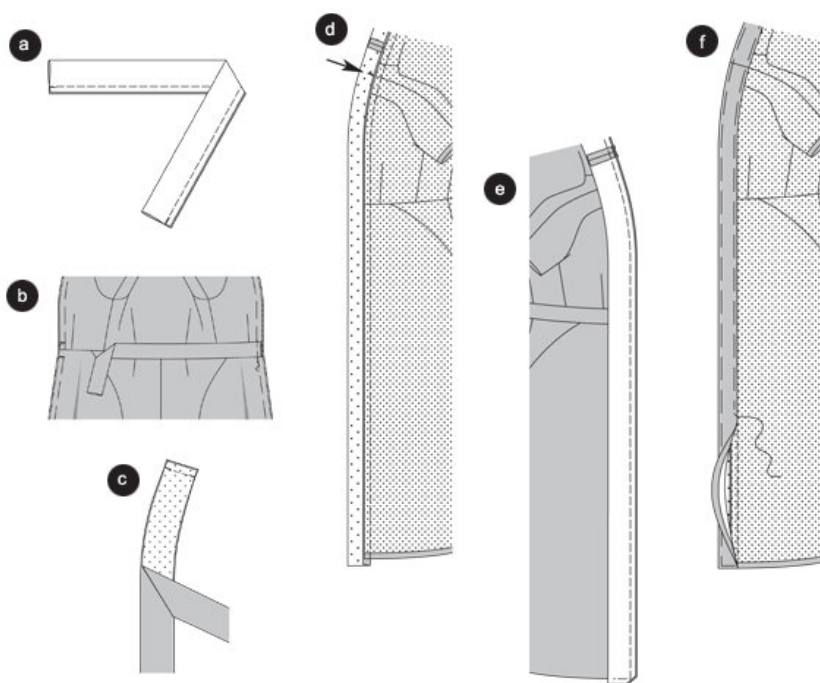

## BELT

Fold the belt along the fold line, right sides facing. Stitch the long edges together. Trim allowances. Turn the belt and press (a).

Position the belt on the skirt seam line. Pin the ends between the cross lines on the front edges (b).

## PLACKET

Position the interfaced plackets together, right sides facing. Stitch the center back seam. Trim allowances narrowly and press apart. Topstitch the center seam of the interfaced plackets ©.

Pin the interfaced plackets on the front dress edge (seam 8/16), right sides facing. The center back seam meets the center back of the bodice; the cross lines meet the upper sleeve seams (arrow). The placket allowance overlaps along the hemline. Stitch. Trim allowances and press inside the placket (d).

Position the interfaced and non-interfaced placket together, right sides facing and the center seams meeting. Stitch the plackets along the front edges and hemline edges. Trim allowances (e).

Fold the edges of the non-interfaced placket inside. Pin the edges and press. Pin the placket on the seam line. Topstitch the placket along the front edge and along the seam line narrowly, thereby enclosing the inner placket edge or sewing it by hand on the seam line (f).

---

## Step 11

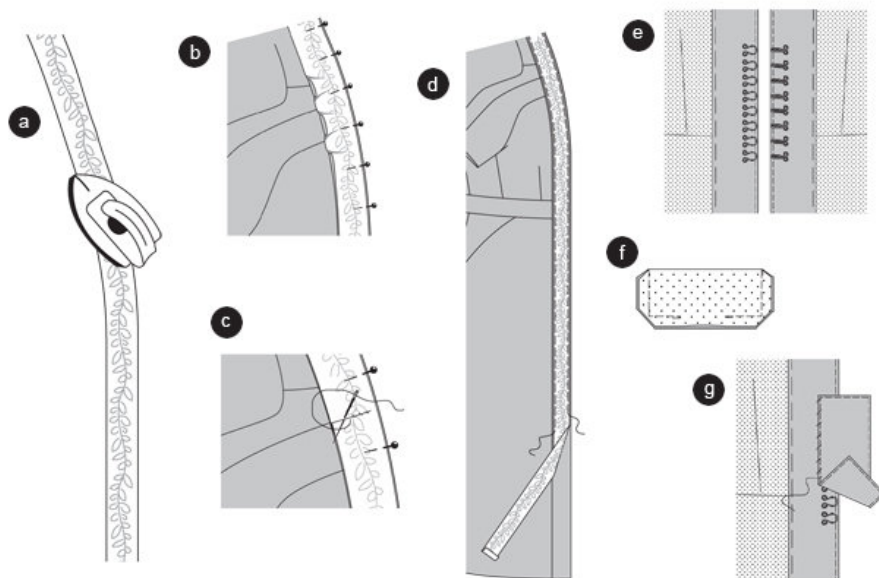

### LACE

Apply the lace all the way along the placket. To adjust the lace to the neckline, slightly press it into form. Test it in advance (a).

If the lace cannot be pressed, pin it to the outer edge of the placket. Along the seam line, the lace will then be too loose. Gather this extra width or stitch a little dart on the lace, sew by hand (b).

Pin the lace. At the hemline, turn the edges inside. Either topstitch the lace edges narrowly (d) or sew it by hand ©.

### HOOKS AND EYES

Tip: Apply the hooks and eyes so that they are invisible. The placket edges should meet if the dress is closed.

Apply 8 hooks on the inside of the right placket (above the waist line) between the cross lines for the underlap. Accordingly, apply 8 eyes on the inside of the left placket (e).

## UNDERLAP

Fold the underlap along the fold line, right sides facing. Stitch the edges together according to the image. Leave an opening. Trim allowances and cut the corners at an angle. Turn the underlap and press the edges. Topstitch the underlap edges (f).

Pin the underlap  $\hat{a}$ ' (1.5 cm) wide on the wrong side of the left placket, between the cross lines. The underlap then covers the eyes. Sew the underlap by hand on the placket (g).

---

## Step 12

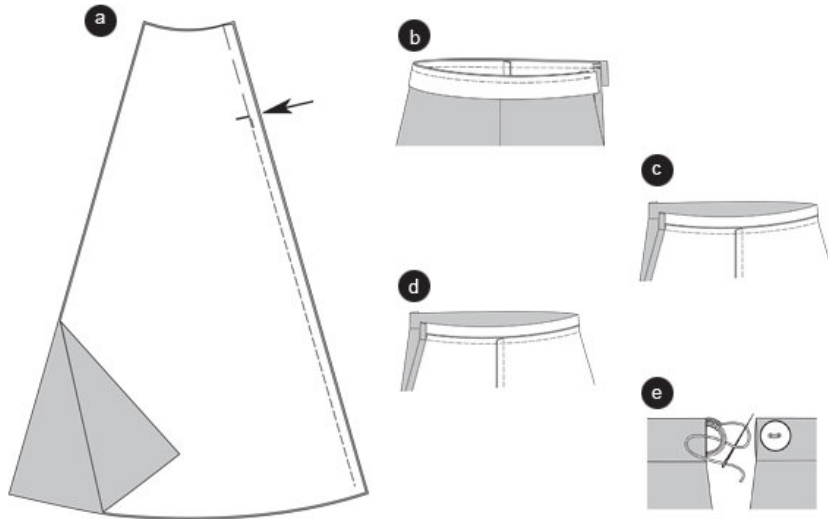

## PETTICOAT

Position 2 skirt panels together, right sides facing. Baste the seam and stitch from the slit sign (arrow) to the bottom. Secure seam ends. Keep the seam basted. Neaten the slit edge allowances separately from the top down to  $2\hat{a}$ ' (5 cm) below the slit sign, press them apart. Neaten the rest of the allowances and press them to the side.

Stitch the seams along the other panels from top to bottom. Neaten allowances and press to the side. Position the skirt panels together, right sides facing, and stitch the other 2 seams the same way (a).

## WAIST BAND

Trim the allowance of the upper skirt edge to  $\hat{a}$ ' (0.7 cm).

Position the waist band on the top skirt edge, right sides facing. Topstitch  $\hat{a}$ ' (0.7 cm) wide (b). Turn the waist band over the allowances and press. Fold the waist band edges inside ©.

Turn the waist band over the edge to the inside, fold and pin so that the waist band edge overlaps 2mm along the seam line. Stitch along the seam line of the waist band, enclosing the inner edge (d).

Sew a thread loop at the front waist band end. Accordingly, apply a button on the back end of the waist band. Fold and press the seam line, fold again and stitch (e).

TIP:

While wearing the dress the petticoat will be visible since the dress is open in the center front. Position the petticoat so that the slit (closure) is placed at the side and no seam visible in the front.

---

**BurdaStyle**

Nora Plus