

# Drafting Sleeve for Basic Bodice Block

By: gedwoods

<http://www.burdastyle.com/techniques/drafting-sleeve-for-basic-bo>

---

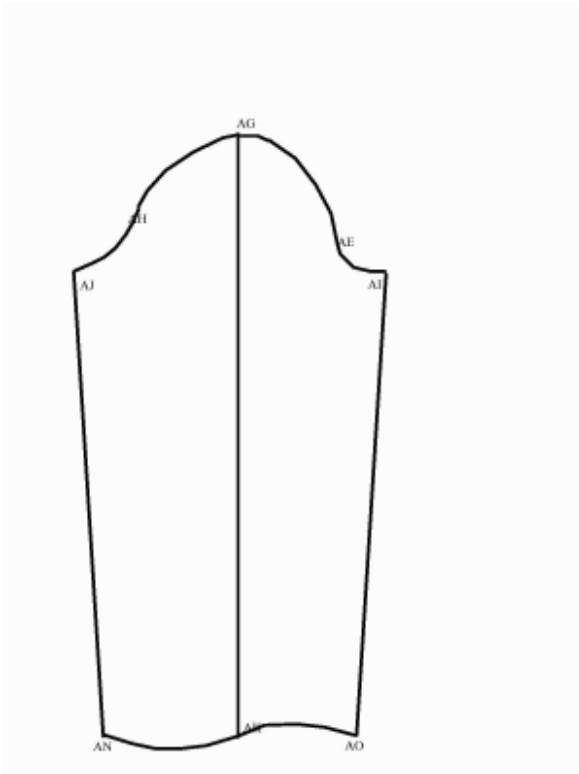

Along with the Basic Bodice Block, to construct patterns for a full range of garments (shirts, blouses, dresses, jackets and coats), you will need an appropriately constructed sleeve as well. In this “how to”, using similar drafting principles as those employed for the Basic Bodice Block, I show you how to construct a pattern for a sleeve that is matched to the Basic Bodice Block (i.e. in terms of size, seam length, etc.). In addition to the BUST measurement, you will need a SLEEVE length measurement for this to work. This block construction method has been adapted from the following reference : Winifred Aldrich, Metric Pattern Cutting for Women’s Wear, 5th ed., Blackwell Publishing: Oxford, 2008, 215 pp.

---

## Step 1

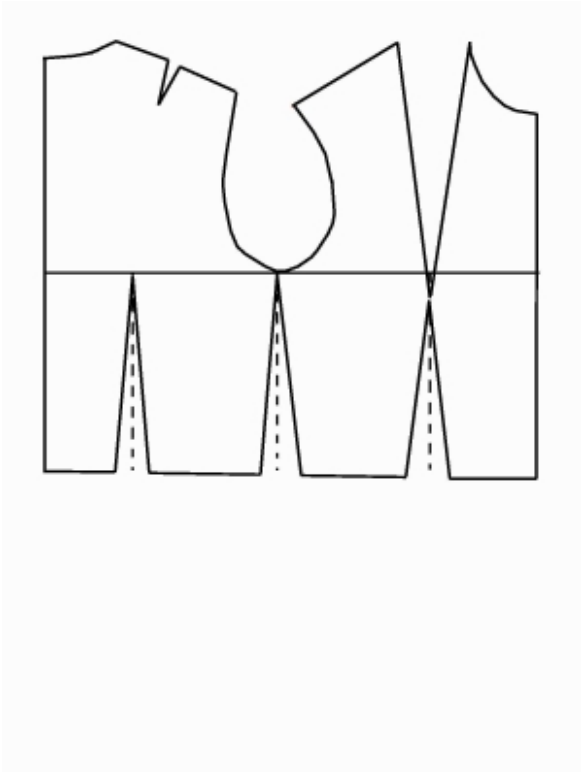

This is the Basic Bodice Block resulting from the companion "How To" ("Constructing the Basic Bodice Block"). In principle, if you followed the instructions, this shape will be cut out of paper or cardboard and can be used to trace around. For the construction of the sleeve, you will need to trace on top of this shape, either by copying the shape to a new large piece of paper or cardboard, or by using a tracing paper overlay.

---

## Step 2

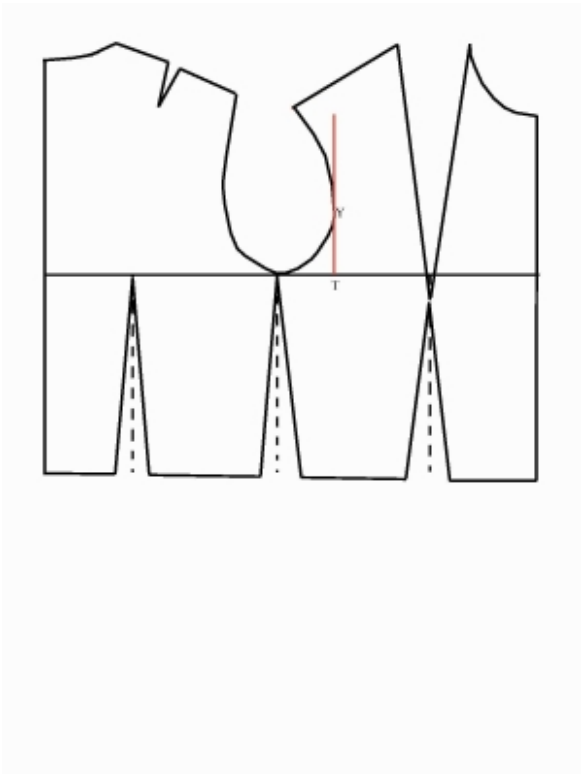

Now, reconfigure the point T and its vertical riser that touches the edge of the ARMSCYE at point Y.

---

### Step 3

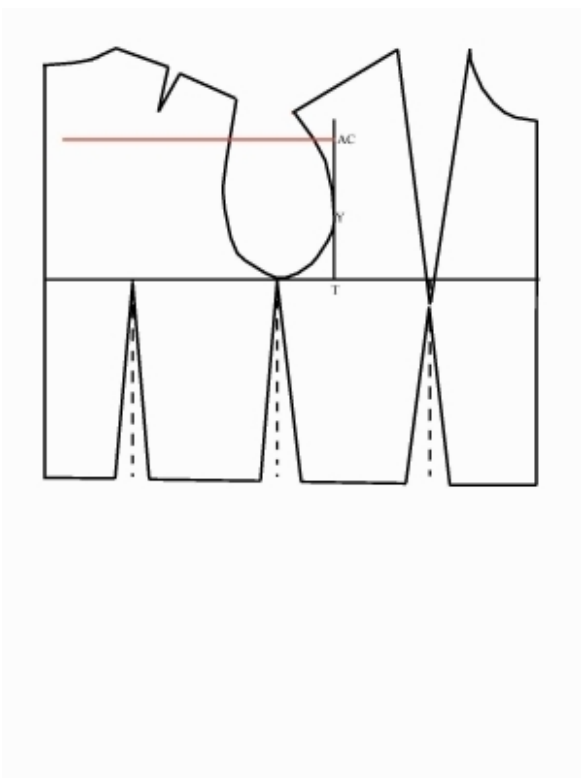

At a distance one third of the ARMSCYE above the point T, mark the point (point AC), draw in a horizontal line towards the left. Note that the measurement used for the Basic Bodice Block was the ARMSCYE DEPTH, defined as half the ARMSCYE measurement. Here we want a third of the full ARMSCYE measurement (which is two thirds of the ARMSCYE depth, if you prefer to think of it this way). This line is also double the distance between the point T and the point Y.

---

#### Step 4

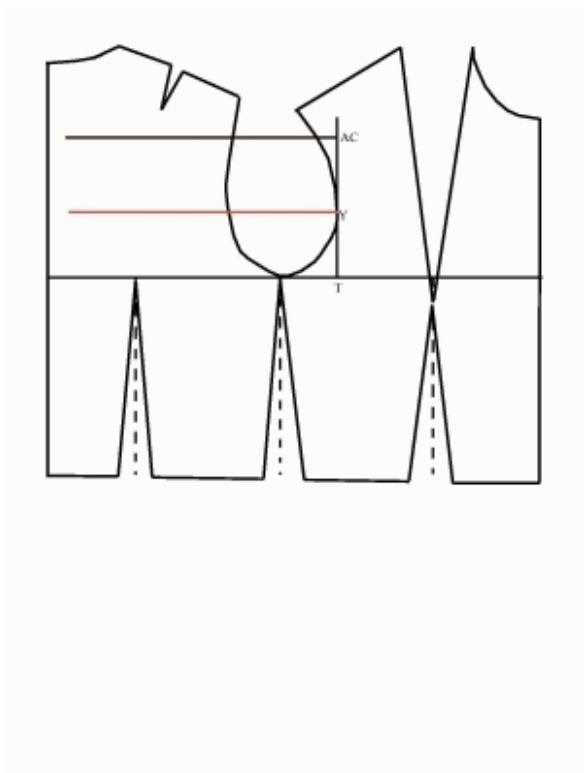

A new horizontal line should be placed at the level of the point Y, hence midway between point T and point AC.

---

#### Step 5

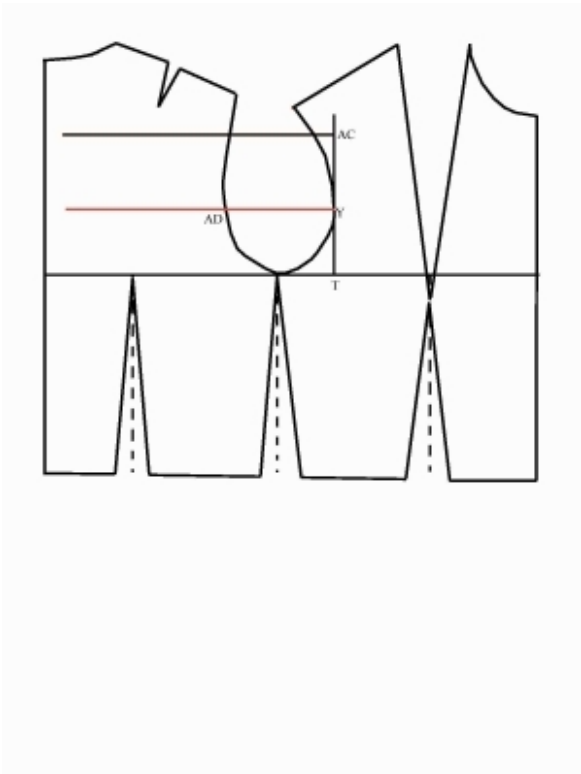

Mark the location where the line from Y crosses the leftmost edge of the ARMSCYE curve (point AD).

---

### Step 6

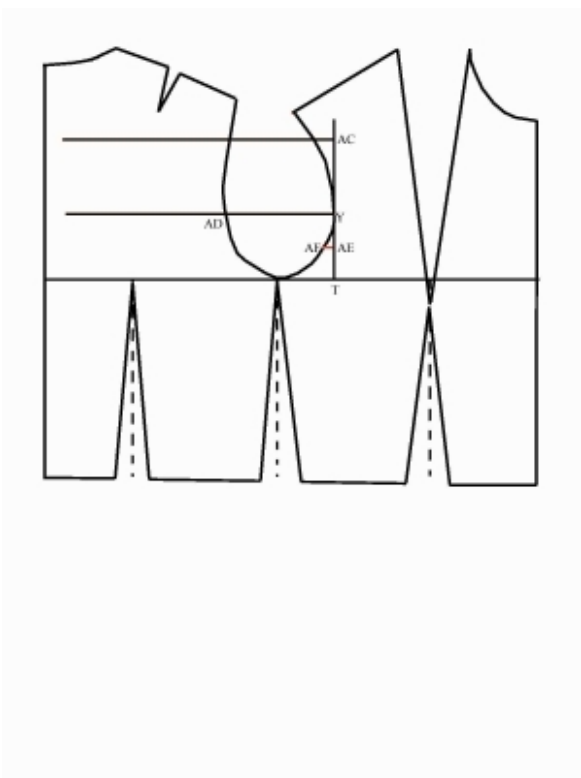

Mark the point halfway between points T and Y (point AE). Draw a very short horizontal line across to the ARMSCYE curve and mark the intersection (point AF).

---

## Step 7

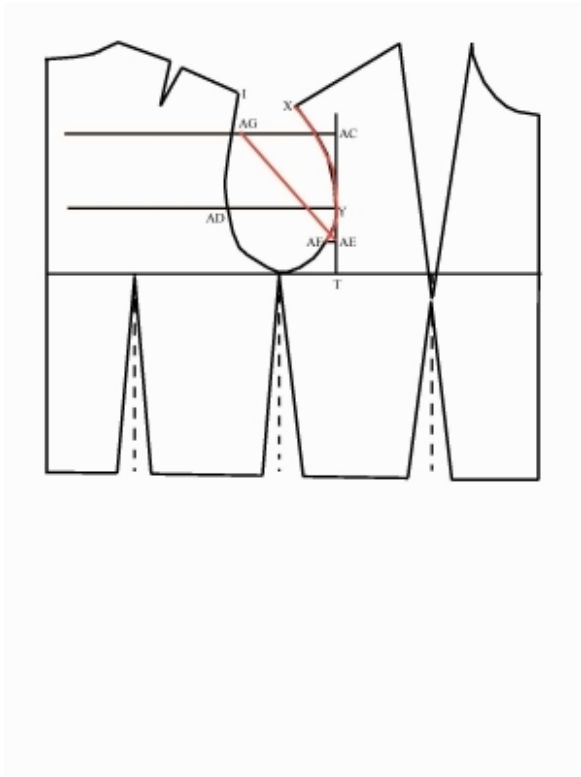

Now, this is a little tricky. You must measure the length of the ARMSCYE curve between point AF and point X at the top - not the length of the straight line connecting points AF and X, but the distance ALONG the curve. If you are careful, you can do this by pivoting the ruler several times. Alternatively, you could drape a small piece of string along the curve and then measure the length of the string when it is straightened out. Now, add 1 cm (2/5") to this (for bust sizes 94 cm to 107 cm or 37" to 42", add 1.25 cm or 1/2", while for bust sizes above this, add 1.5 cm or 3/5"), locate the zero of the ruler at AF, and pivot the ruler until this length meets the horizontal line at AC. Mark the point at the intersection (point AG).

---

## Step 8

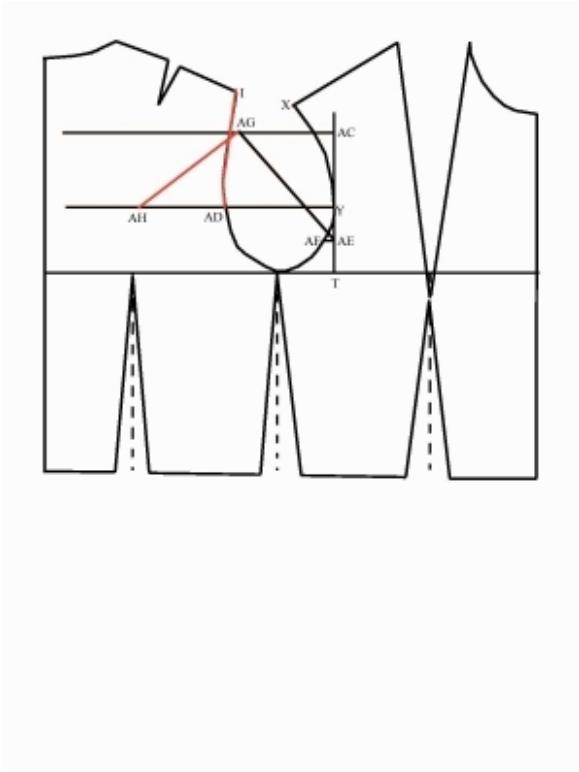

Measure the distance again ALONG the curve between point AD and point I at the top of the left part of the ARMSCYE curve. Add 1 cm or 2/5" to this distance (1.25 cm or 1/2" for bust sizes between 94 cm and 107 cm or between 37" and 42", and 1.5 cm or 3/5" for larger bust sizes) and using the zero of the ruler anchored at point AG, pivot the ruler around until the intersection with the horizontal line at the Y level corresponds to the length just calculated (point AH). As usual, it is harder to explain than to do!

---

## Step 9

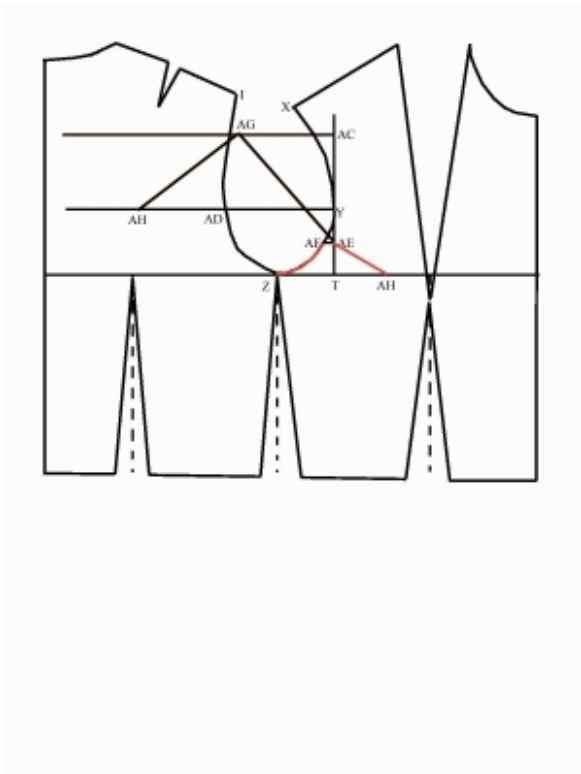

Measure the distance from Z to AF ALONG the curve, subtract 0.3 cm (1/8"), and draw a straight line from point AE to the horizontal line that passes through T with the resultant length (point AI).

---

### Step 10

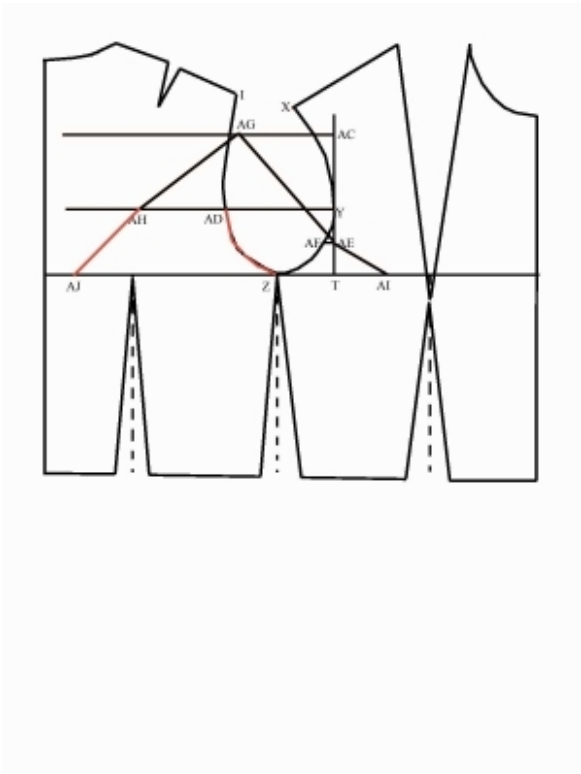



Measure the distance ALONG the curve from AD to Z, subtract 0.3 cm (1/8"), and draw a straight line from the point AH to the horizontal line passing through T and Z at the resulting length. Mark this point (point AJ).

---

### Step 11

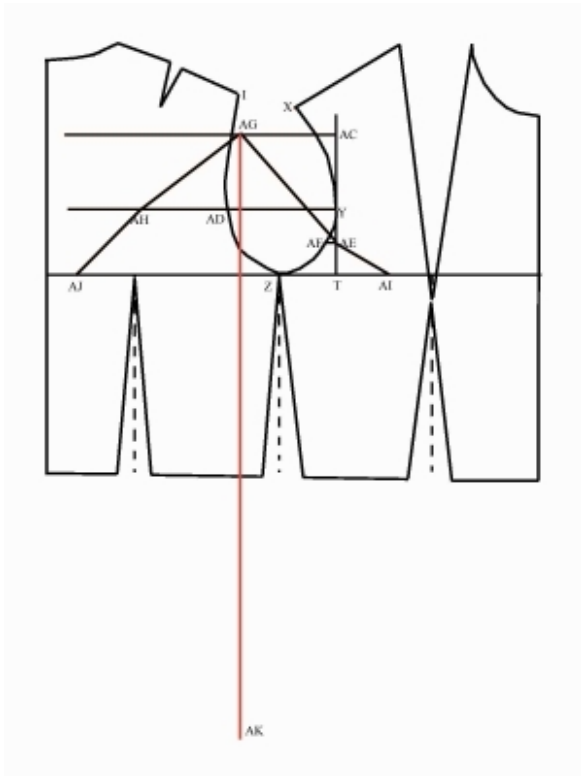

Now drop a line vertically from the summit point AG, the length of the SLEEVE measurement (point AK).

---

### Step 12

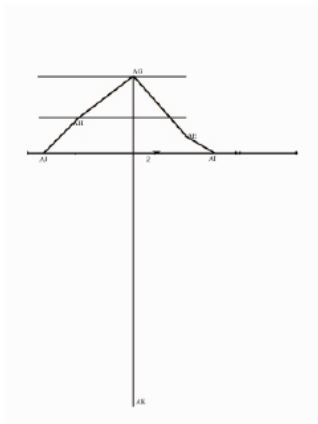

Now, the Basic Bodice Block is no longer needed and adds confusion, so I have removed it along with the construction lines we no longer need. This is just to improve the clarity of the next set of instructions.

---

## Step 13

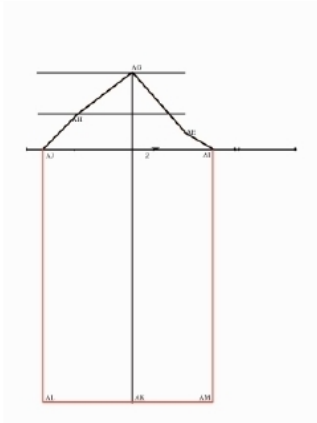

Drop vertical lines from points AI to the horizontal line passing through AK (point AL), and from AJ to the same horizontal line (point AM), and draw in the horizontal line from AL to AM.

---

## Step 14

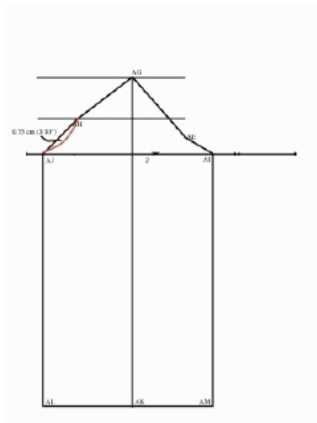

Now, draw in a curve from AI to AH, hollowed below the diagonal by a maximum of 0.75 cm (3/10").

---

## Step 15

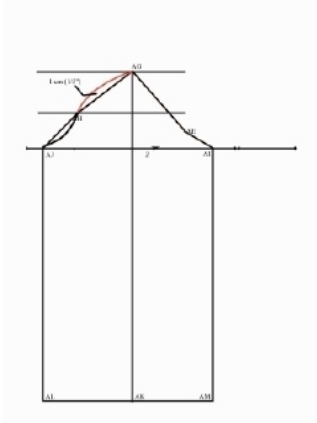

Continue the curve above the line from AH to AG, raised 1 cm (2/5") at maximum deviation. Make sure that the curve flattens to the horizontal as it passes through point AG.

---

### Step 16

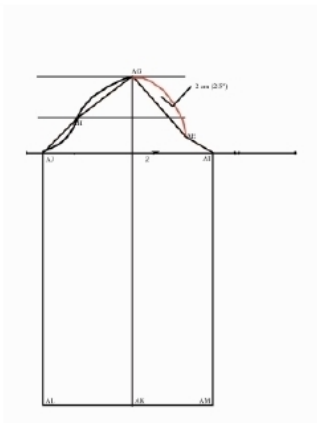

Continue the curve downwards to point AE, passing 2 cm at maximum deviation above the line connecting AG and AE.

---

### Step 17

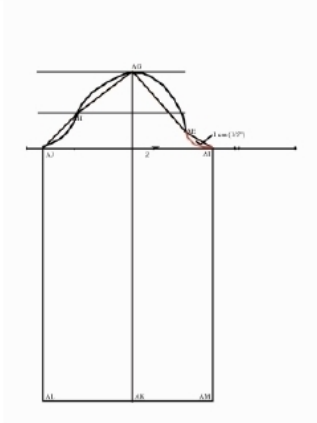

Finish the curve of the sleeve head but dropping it below the line connecting AE and AI by 1 cm (1/5") at maximum deviation, and making sure it approaches the horizontal at point AI. Note that the sleeve head shape is asymmetrical - this is as it should be.

---

## Step 18

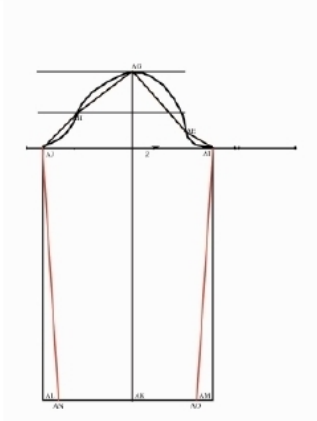

If you wish to introduce some shaping into the sleeve, you may narrow the sleeve by a distance of from 1 to 3 cm (1/4" to 1") on each side.

---

## Step 19

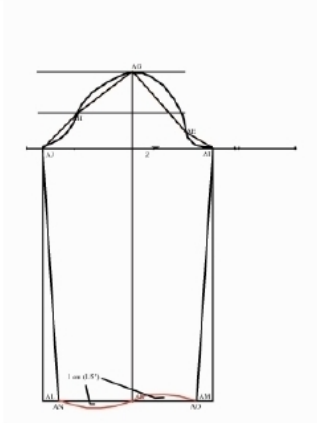

Lower the sleeve edge curve by 1 cm (2/5") on the section between AN and AK (the back section of the sleeve), and raise it by 1 cm (2/5") on the section between AK and AO (the front section of the sleeve).

---

## Step 20

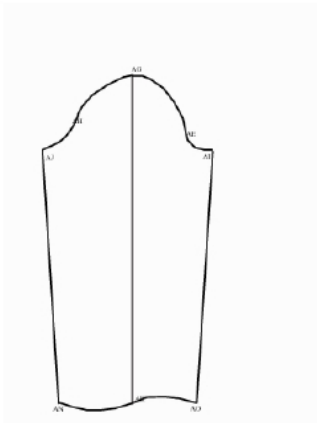

This is the final outline of the sleeve. Note that the waist line on the bodice block marks the location of the elbow on the sleeve. This is a one piece sleeve, a different drafting procedure is used to construct a two-piece sleeve. I hope this "how to" is useful to you!

---

**BurdaStyle**

Drafting Sleeve for Basic Bodice Block