

122 Skirt

Burda sizes 34, 36, 38, 40, 42

Length from waist 62 cm (24 1/2 ins)

Upper edge of skirt 4 cm (1 5/8 ins) above waist

Materials

Reversible knit fabric,
width: 160 cm (63 in)

length: 0.80 – 0.80 – 0.80 – 1.05 – 1.05 m
(7/8 – 7/8 – 7/8 – 1 1/4 – 1 1/4 yds).

Stretch lining,

width: 140 cm (55 in)

length: 1.05 m (1 1/4 yds) for all sizes.

Interfacing.

1 invisible zip, 40 cm (16 ins) long.

Recommended fabrics: Skirt fabrics with some body. Fabrics with elastane are ideal.

Preparations

Print the pattern out on letter or A4 sized paper. It is **very** important to not scale the document. Your pattern will print on multiple pages, which you will then tile together. Arrange the sheets on a large, hard and flat surface matching up the numbers and letters (i.e. 6A to 6A). Cut or fold one of the sides and match the edge to its corresponding side. Then, tape down in place so paper is secure.

Trace the pattern pieces from the pattern sheet following the lines and markings for style 122 and your size. Trace the pocket piece from piece 21 as a separate pattern piece.

burda style magazine patterns do not have seam allowance included.

Seam and hem allowance to be added:

Seams and edges 1.5 cm (5/8 in), hem 4 cm (1 5/8 ins), lining 1.5 cm (5/8 in).

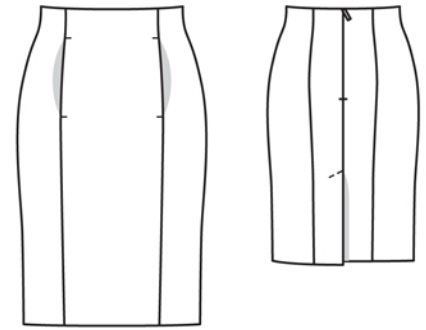
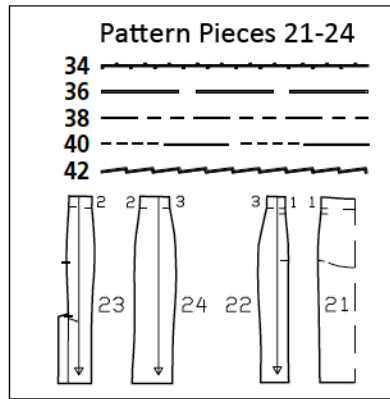

Fold the fabric as shown in the pattern layout. Right side faces in on a double layer of fabric. Right side faces up on a single layer. Cut right and left pieces as opposites.

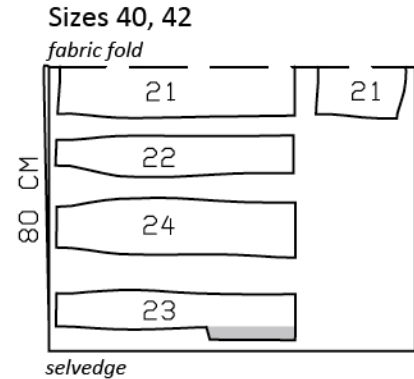
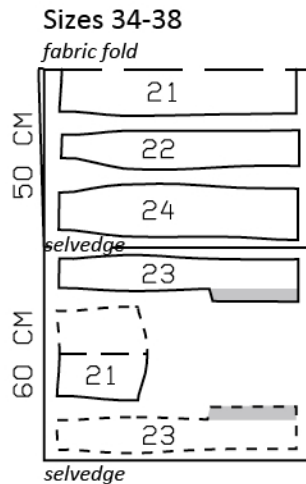

Cutting Out

Jersey:

- 21 centre front skirt panel
on a fold 1x
- pocket piece, on a fold 1x
- 22 side front skirt panel 2x
- 23 centre back skirt panel 2x
- 24 side back skirt panel 2x

Lining: pieces 21 to 24, and also pocket pieces.

Interfacing: See pattern layout. Iron shaped strips of interfacing, 6 cm (2 3/8 ins) wide, to wrong side of upper edges of skirt lining panels.

Sewing

Note: Stitch seams on stretch fabrics with a special stretch stitch or at a narrow, zigzag setting.

Lay pocket lining piece right sides together with centre front skirt panel. Stitch to pocket opening edges, stitching across seam allowance at each marking. Clip seam allowances into corners. Trim allowances on pocket opening edges. Turn pocket piece to inside. Press pocket opening edges. Baste pocket piece to wrong side of skirt panel, above pocket opening edges. Lay fabric pocket piece underneath. Leave allowances at pocket opening edges extending. Baste upper edge in place. Stitch lower edges of pocket pieces together.

Stitch front section seams, not catching pocket opening edges of the centre front skirt panel. Stitch back section seams and side seams. Press seam allowances open.

Invisible zip with centre seam, vent: Sew the invisible zip to back opening edges, see the "Helpful Hint" on next page. Stitch the centre back seam from vent to zip. Trim away bottom of zip approx. 2 cm (3/4 in) below opening and bind with a scrap of fabric. At the vent, press allowances onto the left skirt panel and press the centre seam allowances open. Above the vent, press seam allowance of right skirt panel to wrong side, tapering as you go (do not clip allowance). Narrowly hem vertical edge of underlap on right back skirt panel. Topstitch left back skirt panel at an angle as marked, catching underlap.

Stitch seams of lining.

Face upper skirt edge: Pull lining over skirt, with right sides facing. Pin upper edges together. At zip opening, turn lining back, approx. 5 mm (3/16 in) before edge of opening, and pin to upper edge. Turn allowances on opening edges of skirt to outside and pin to upper edge of skirt, over lining. Stitch along upper edge of skirt. Turn allowances at opening edges to inside. Turn lining up and stitch to seam allowances, as far as possible, close to seam. Turn lining to inside and sew to zip tapes.

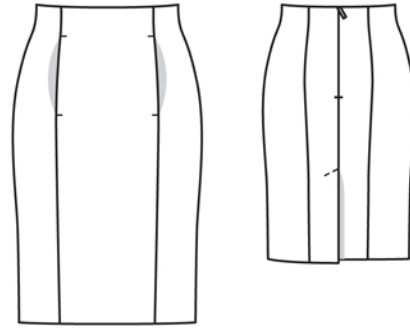

Hem and lining hem: At hem edge, unfold the vent facing. Press hem allowance to inside and stitch hem in place by hand. Sew facing to hem edge. Hem the lining so that it is approx. 2 cm (3/4 in) shorter than the skirt.

Sew lining in place at vent: Pin centre back seam of skirt and lining together at top of vent. At edges of vent, lay lining allowances in same direction as on skirt (clip lining allowance approx. 1 cm / 3/8 in above top of vent). At vent, turn up skirt lining piece which lies on top. Turn under skirt lining which lies below and pin to hem edge of underlap. Sew in place by hand. Lay skirt lining piece down again and cut horizontally, 1 cm (3/8 in) below top of vent, up to 1 cm (3/8 in) before edge of underlap, then cut down to hem edge, 1 cm (3/8 in) from edge of underlap. Clip diagonally into corner, approx. 1 cm (3/8 in) long. Turn in edges of lining. Sew horizontal edge to underlap and sew vertical edge to slit facing.



These special zippers come in various lengths. The zipper should be at least 2 cm (3/4 in) longer than the slit. It is sewn in place before the seam below the slit is stitched. A special presser foot is required to sew the zipper in place.

Sewing the zipper in place:

Open the zipper and push the coil back with your thumbnail to reveal the seam marking between the tape and the coil. Place the open zipper right side down on the right fabric side of one slit edge.

In order to stitch the zipper in place exactly along the marked seam line, you must first calculate the distance between the tape edge and the fabric edge as follows: width of seam allowance minus 1 cm (3/8 in) tape width = distance from edge of fabric. This will yield a value of 5 mm (3/16 in) if the width of the seam allowance is 1.5 cm (5/8 in).

Pin the top end of the zipper tape in place, the calculated distance from the edge of the fabric. The bottom end of the zipper will extend past the marked end of the slit. Place the presser foot on the zipper so that the coil is in the notch to the right of the needle (1). Stitch zipper in place, from the top to the marked end of the slit. Close zipper.

Place the other zipper tape face down on the opposite slit edge and pin in place at the top. Open zipper again. Place the presser foot on the top end of the zipper so that the coil is in the notch to the left of the needle (2). Sew the zipper in place, from the top to the end of the slit. Close zipper.

Now stitch the seam below the zipper, from bottom to top. Turn the loose lower end of the zipper out of the way, over the seam allowance. Stitch as close as possible to the last stitches of the zipper seams. Trim away excess zipper and bind the end with a scrap of fabric.

Additional Information:

Burda patterns do not include seam and hem allowances. We recommend adding 1-2 cm (3/8 - 3/4 inch) for seams and 2-5 cm (3/4 - 2 inch/es) for hems. Refer to your specific pattern instructions for exact measurements.

The fabric requirements are based on the fabric used for the original designs. These amounts will change if you use fabric of a different width. The pattern of the fabric determines whether all the pieces must be cut in the same direction or whether some can be reversed to save fabric.

The cutting layout printed with the instructions shows the best way to place the pattern pieces on our original fabric. Fold the fabric double with the right side facing in. The fabric then has a fold edge and a selvedge edge. When cutting from a single fabric layer, the right side should face up.

Pattern pieces which are shown in the cutting layout with broken outlines should be pinned to the fabric with their printed side facing down.

Grey shaded areas in the cutting layout indicate which pieces are to be interfaced.

Transfer the pattern piece lines to the wrong side of your fabric with burda dressmaker's carbon paper. Hand-baste along lines (e.g. for pockets or centre front) to make them visible on the right side of the fabric.

Key Symbols:

Seam numbers

show where pattern pieces must be sewn together. Match pieces with the same numbers.

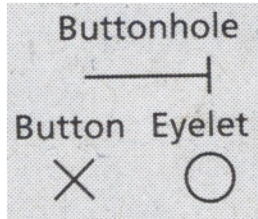
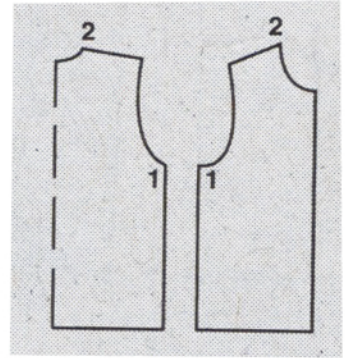

Seam marks

on long seams. Match the small symbols to one another.



Presser foot is the symbol for seam and top-stitching lines.



Scissors

indicate edges to be cut without seam allowances and also slash lines, e.g. pocket openings.



Pleat symbol

Fold pleat in direction of arrow.



Placket/slit mark

Indicates beginning/ end of placket/slit.



Gather
Ease
Stretch

