

### 110 Dress

Burda sizes 34, 36, 38, 40, 42, 44

#### Materials

Stretch jersey,  
width: 145 cm (57")  
length :sizes 34 to 44: 1.50 m (1¾ yds)

Fusible interfacing, 90 cm (35½") wide and 0.10 m (1/8 yd) long

Bias tape

Recommended fabric: stretch jersey. Use stretch jersey fabrics only.

#### Preparations

Print the pattern out on letter or A4 sized paper. It is very important to not scale the document. Your pattern will print on multiple pages, which you will then tile together. Arrange the sheets on a large, hard and flat surface matching up the numbers and letters (i.e. 6A to 6A). Cut or fold one of the sides and match the edge to it's corresponding side. Then, tape down in place so paper is secure.

Trace the pattern pieces from the pattern sheet following the lines and markings for style 110 and your size. Trace pattern piece 3 twice. There are no pattern pieces for the facing strips and shoulder loop.

**burda style magazine patterns do not have seam allowance included.**

Seam and hem allowance to be added:

No allowance on lower skirt edges, 1.5 cm (5/8") on the integrated straps and shoulder edge, 1 cm (3/8") on other edges and seams.

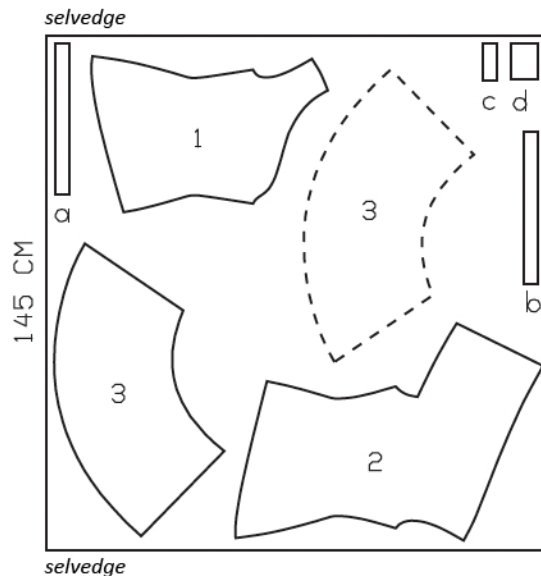
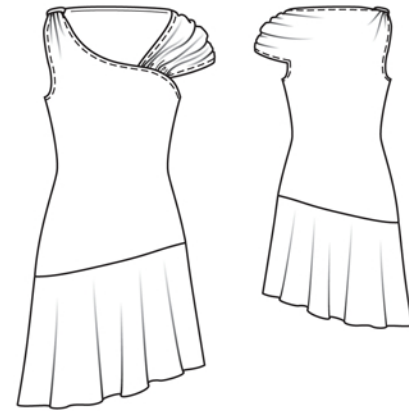
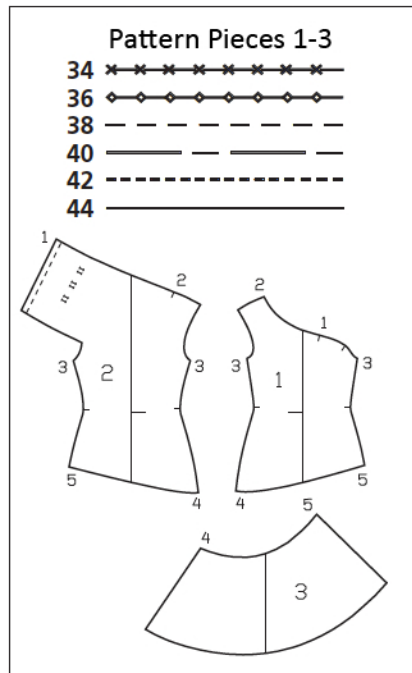

Lay out fabric, right side upward. Lay pattern pieces 1, 2 and front skirt panel on fabric, marked side facing up. Lay back skirt panel on fabric with marked side facing down. Pin in place.

#### Cutting Out

- 1 Front
- 2 Back with integrated straps
- 3 Skirt panel

Draft the following pieces NOT included in the pattern:

a, b, c) 4 cm (1 5/8") wide facing strips for:

a) front neck edge, 41 – 43 – 44 – 46 – 47 – 48 cm (16¼" – 17" – 17¼" – 18" – 18½" – 19") long,

b) right armhole, 41 – 42 – 44 – 45 – 46 – 47 cm (16¼" – 16½" – 17¼" – 17¾" – 18" – 18½") long,

c) left back armhole, for all sizes 10 cm (4") long,

d) loop, 10 cm (4") long, 7.5 cm (3") wide.

**Sewing**

Iron fusible interfacing to fabric: (image 1)  
Iron Vilene Bias Tape/stay tape to wrong side of armhole edges and front neck edge. The chain stitch should be 1 cm (3/8") from edge of fabric. Press for approx. 8 seconds, at silk setting. Cut two strips of fusible interfacing, Vilene G 785, approx. 55 cm (21¾") long and 2 cm (¾") wide, and iron to the wrong side of the lower edges of front and back pieces.

Attaching skirt panels: (image 2)  
Pin the front skirt panel to the lower front edge, right sides facing. Pin the back skirt panel to the lower back edge, right sides facing. Stitch (seam allowance width 1 cm (3/8")). Backstitch at start and end of each seam to secure. Finish seam allowances together and press upwards.

Front neck edge: (image 3)  
Fold facing strip (a) lengthwise in half, and press. Pin the strip to the neck edge (right side) so that the open edges are lying on the edge of the fabric. Stitch the open edges in place, 1 cm (3/8") from fabric edges. Trim seam allowances. Turn strip to inside and baste. Press the edge, but don't topstitch it yet.

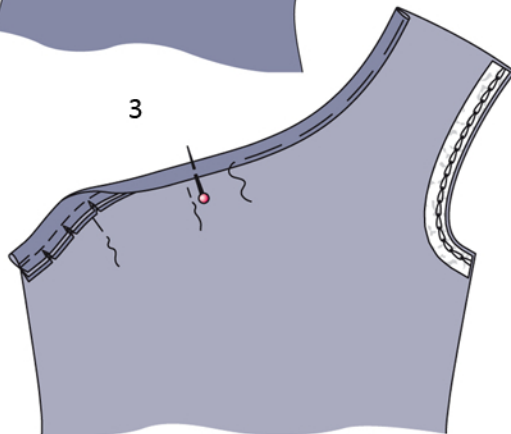
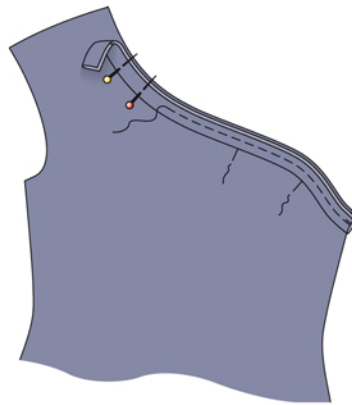
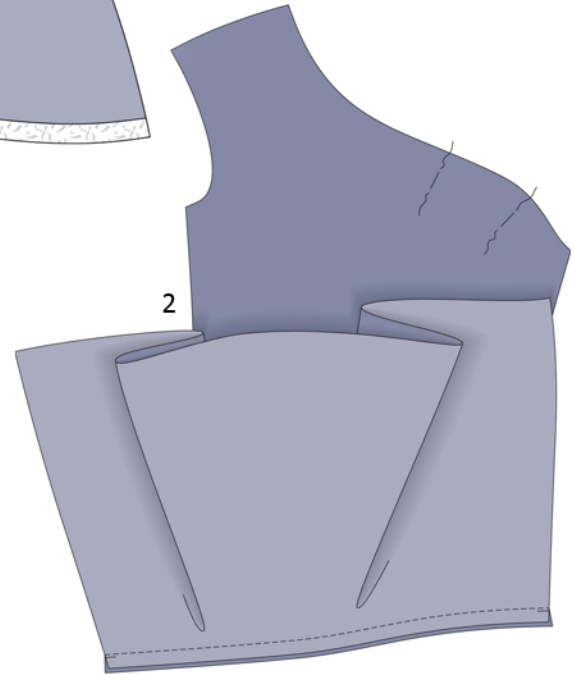
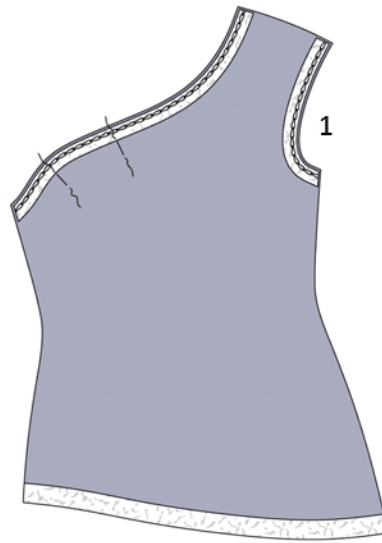

### Sewing Continued...

Left back armhole: (image 4)

Press facing strip (c) (see Step 3) and stitch to the back armhole, from the side edge to the corner. Clip the seam allowance of the back piece into the corner, close to the last stitch. Trim the allowances along the seam. Turn the strip to inside, press the edge, and topstitch 5 mm (3/16") from the edge.

Right shoulder seam: (image 5)

Lay front piece on back piece, right sides facing. Pin the right shoulder seam – the neck edge of the front piece should meet the notch (seam number 2). Stitch the shoulder seam (seam allowance width 1.5 cm, 5/8"). Press the seam allowances toward the back, but don't finish the edges yet.

Strap edges: (image 6)

Press the 1.5 cm (5/8") wide allowances on the long edges of the strap to the wrong side. Turn edges of allowances under by 7 mm (¼") – running at an angle under the shoulder seam. Press. Finish edges of the shoulder seam allowances together. Topstitch 5 mm (3/16") from the strap edges, on the upper edge stitching as far as the shoulder seam and on lower edge, as far as the stitching line on the armhole.

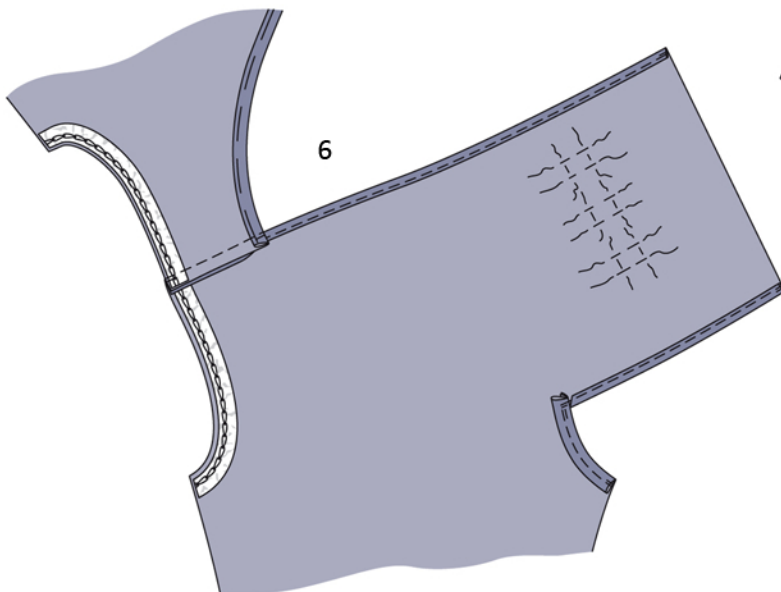
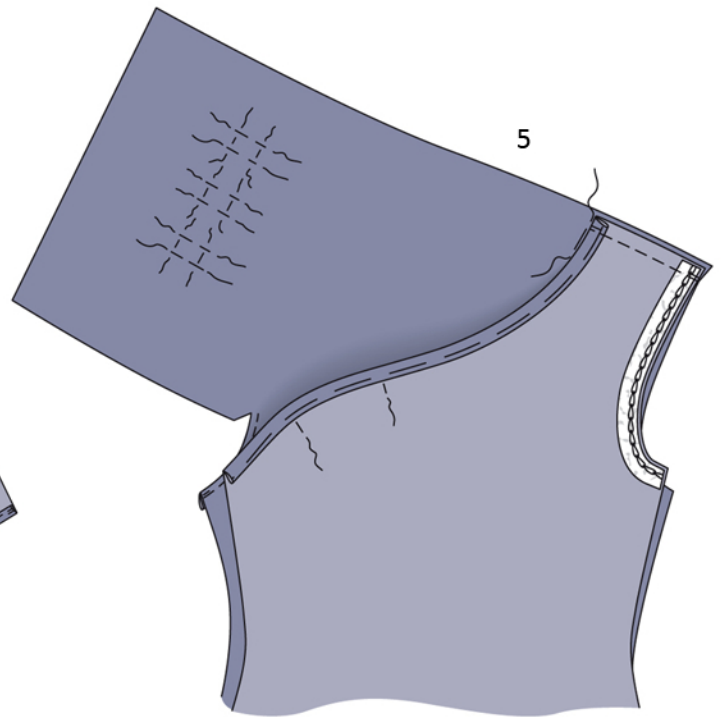
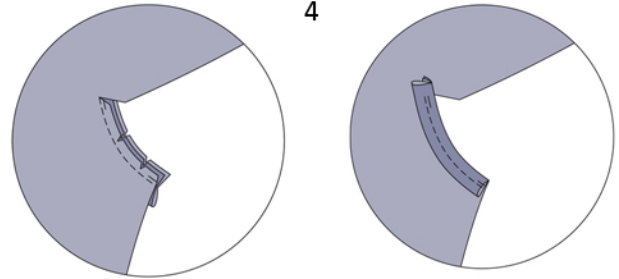
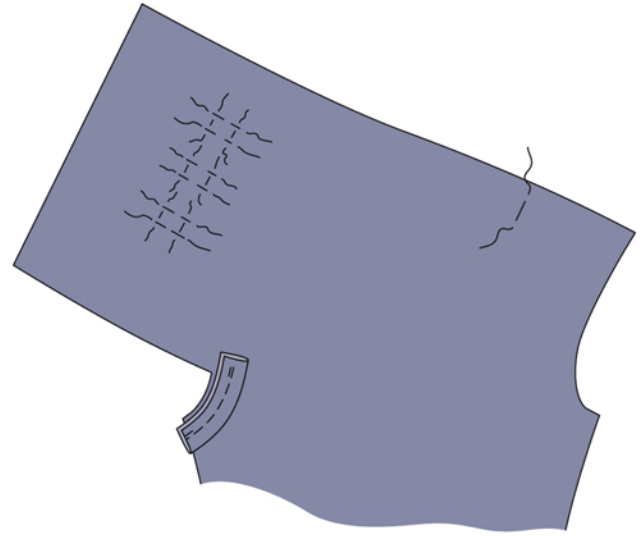

### Sewing Continued...

#### Stitch tucks on strap: (image 7)

Fold the strap along one marked tuck fold line, wrong side facing in. Topstitch 1.5 cm (5/8") from the tuck fold, as marked. Stitch the other two tucks in the same way.

#### Right armhole: (image 8)

Press the facing strip (b) and stitch to the right armhole edge, right sides facing (seam allowance width 1 cm, 3/8"). Trim the allowances along the seam. Turn the strip to the inside, press the edge, and topstitch 5 mm (3/16") from the armhole edge.

#### Side seams: (image 9)

Lay the front piece on the back piece, right sides facing. Pin the side seams so that the skirt attachment seams match. Stitch (seam allowance width 1 cm (3/8")). Press seam allowances open and finish the edges. Sew the upper ends of the seam allowances to the armhole edges by hand.

#### Gather end of strap: (image 10)

To gather strap end, machine baste 1.2 cm (1/2") from the end of the strap and again 5 mm (3/16") from the 1st line of stitching. Hold the bobbin threads of the stitching and gather the fabric to 9 cm (3 1/2") for size 34, 9.5 cm (3 3/4") for size 36, 10 cm (4") for size 38, 10.5 cm (4 1/8") for size 40, 11 cm (4 3/8") for size 42, and 11.5 cm (4 1/2") for size 44. Knot gathering threads.

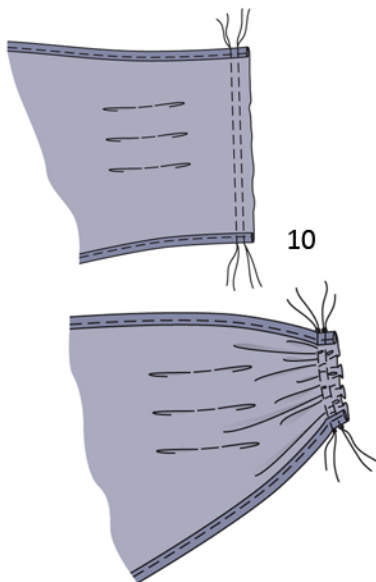
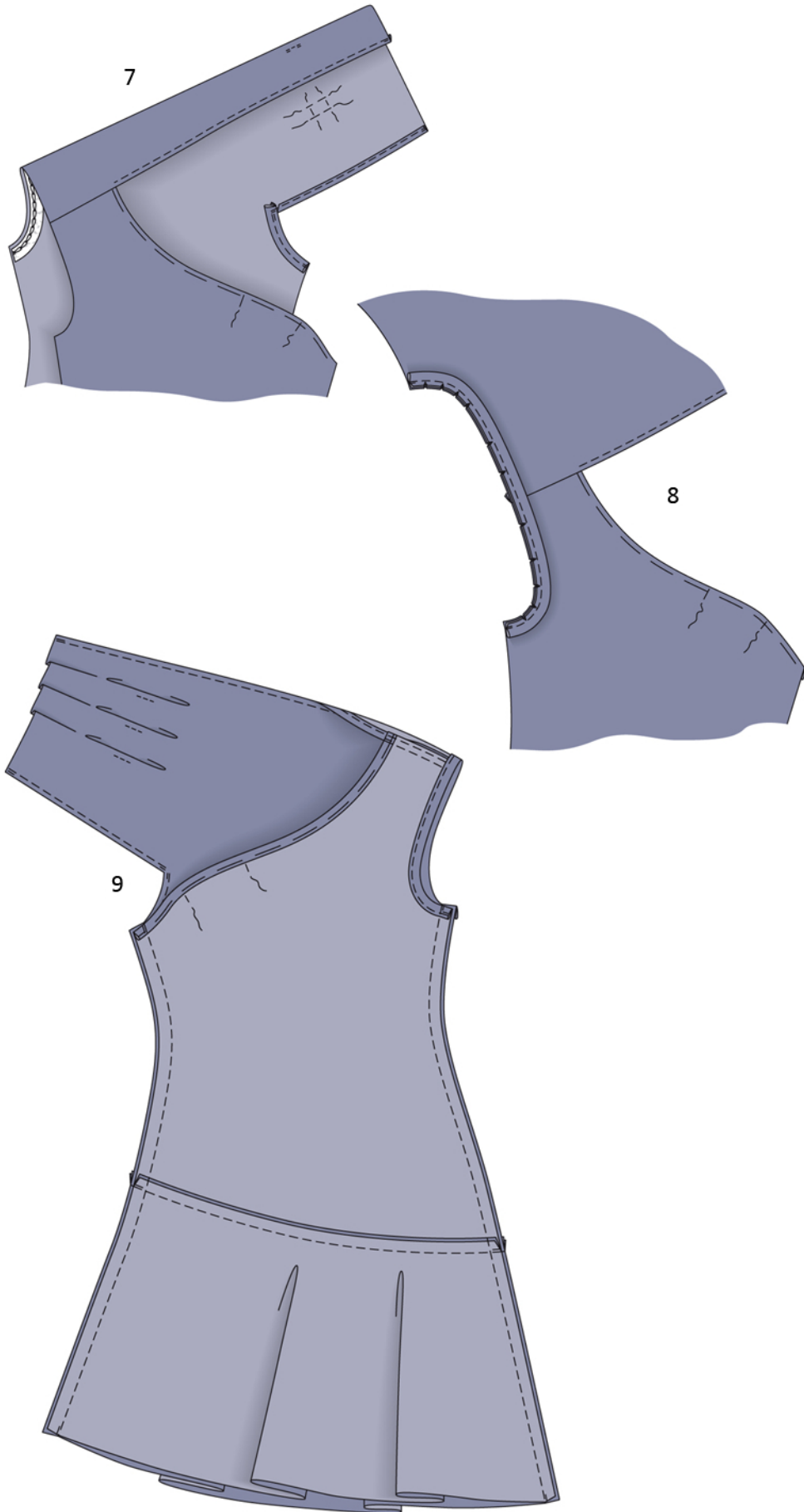

### Sewing Continued...

Stitch strap in place: (image 11)

Turn the facing strip on the front neck edge up again. Lay the end of the strap on the front neck edge, between the notches, right sides facing. Pin together exactly on the attachment seam of the facing strip. Try on, and then stitch the strap in place.

Topstitch front neck edge: (image 12)

Lay both the facing strip of the front neck edge and the seam allowance on the end of the strap section onto the front piece and pin in place. Topstitch 5 mm (3/16") from the front neck edge, thereby stitching the facing strip and the end of the strap in place.

Shoulder loop: (image 13)

Press the long edges of the loop piece (d) to the wrong side, 2.5 cm (1") wide. Press one narrow end to wrong side, 1.5 cm (5/8") wide. Lay the loop around the shoulder seam. On the underside, pin the turned-under edge to the opposite end of the loop and sew in place by hand.

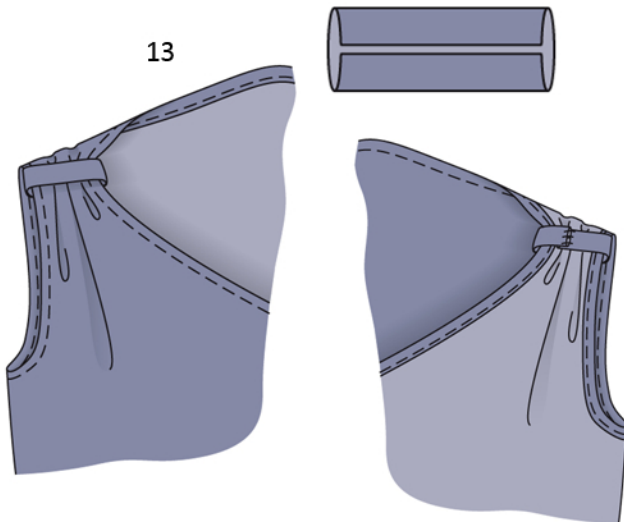
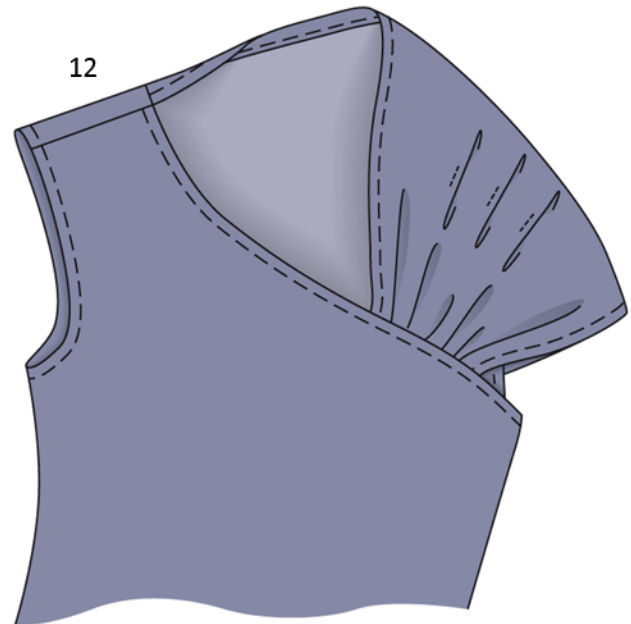
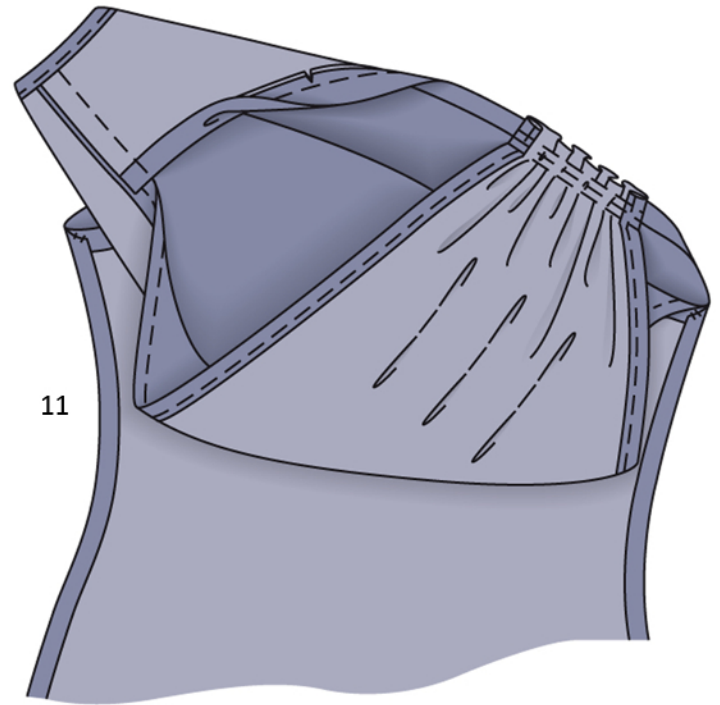

## Additional Information:

**Burda patterns do not include seam and hem allowances.** We recommend adding 1-2 cm (3/8 - 3/4 inch) for seams and 2-5 cm (3/4 - 2 inch/es) for hems. Refer to your specific pattern instructions for exact measurements.

The fabric requirements are based on the fabric used for the original designs. These amounts will change if you use fabric of a different width. The pattern of the fabric determines whether all the pieces must be cut in the same direction or whether some can be reversed to save fabric.

The cutting layout printed with the instructions shows the best way to place the pattern pieces on our original fabric. Fold the fabric double with the right side facing in. The fabric then has a fold edge and a selvedge edge. When cutting from a single fabric layer, the right side should face up.

Pattern pieces which are shown in the cutting layout with broken outlines should be pinned to the fabric with their printed side facing down.

Grey shaded areas in the cutting layout indicate which pieces are to be interfaced.

Transfer the pattern piece lines to the wrong side of your fabric with burda dressmaker's carbon paper. Hand-baste along lines (e.g. for pockets or centre front) to make them visible on the right side of the fabric.

## Key Symbols:

### Seam numbers

show where pattern pieces must be sewn together. Match pieces with the same numbers.

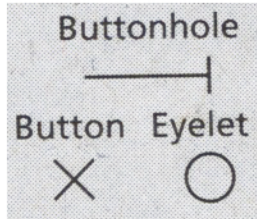
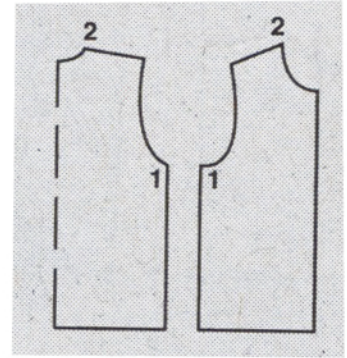

### Seam marks

on long seams. Match the small symbols to one another.



**Presser foot** is the symbol for seam and top-stitching lines.

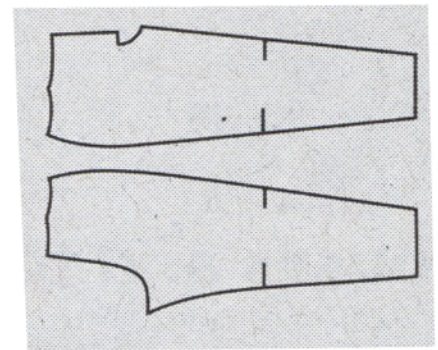

### Scissors

indicate edges to be cut without seam allowances and also slash lines, e.g. pocket openings.



### Pleat symbol

Fold pleat in direction of arrow.

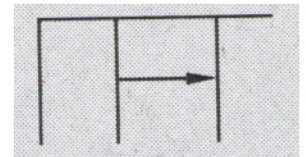

### Placket/slit mark

Indicates beginning/end of placket/slit.



**Gather**  
**Ease**  
**Stretch**

