

118B Top

Burda sizes 34, 36, 38, 40, 42, p. 28

Back length approx. 57 cm (22 1/2 ins)

Materials

Techno-gabardine,
width: 148 cm (58 ins)
length: 1.35 – 1.40 – 1.40 – 1.45 – 1.45 m
(1 5/8 – 1 5/8 – 1 3/4 – 1 3/4 yds).

Interfacing.

1 invisible zip, 60 cm (24 ins) long.

Recommended fabrics: Lightweight fabrics with some body.

Preparations

Print the pattern out on letter or A4 sized paper. It is **very important** to not scale or fit any of the pages, you must print the document in **actual size**. Your pattern will print on multiple pages, which you will then tile together. Arrange the sheets on a large, hard and flat surface matching up the numbers and letters (i.e. 6A to 6A). Cut or fold one of the sides and match the edge to it's corresponding side. Then, tape down in place so paper is secure.

Trace the pattern pieces from the pattern sheet following the lines and markings for the correct size and the correct style (118B). This pattern also includes pattern pieces, lines and markings for style 117 & 118A that should be ignored.

burda style magazine patterns do not have seam allowance included.

Seam and hem allowance to be added:
4 cm (1 5/8 ins) for hem and sleeve hems (flare sleeve hem allowances) and 1.5 cm (5/8 in) at all other seams and edges.

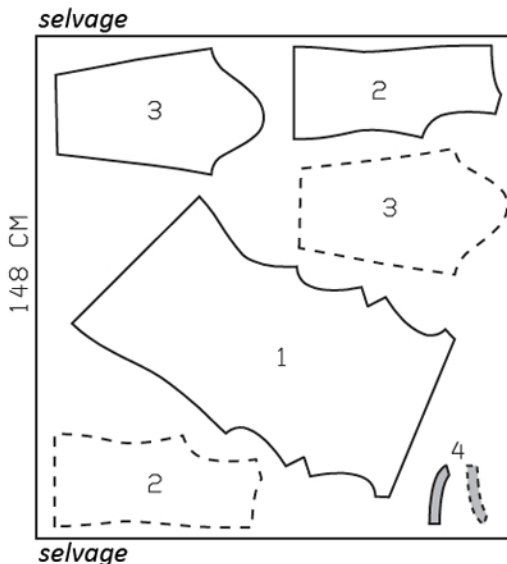
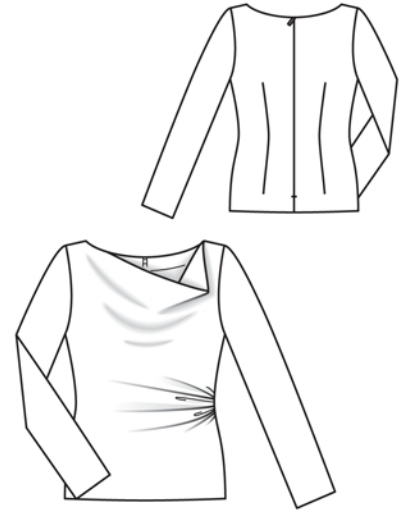
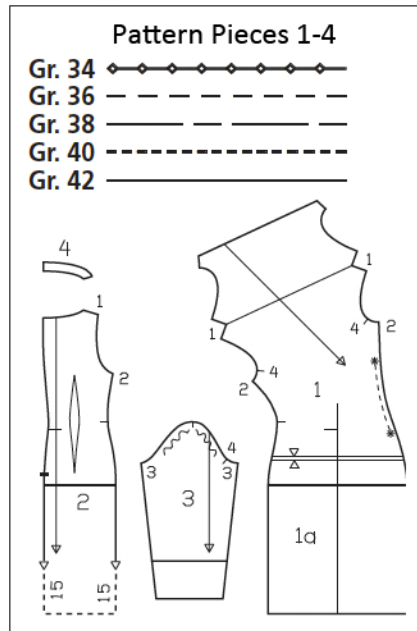

Right side faces up on a single layer of fabric. Lay the asymmetric front piece on the right side of the fabric, with the printed side of the pattern piece facing up.

Cutting Out

- 1 front 1x
- 2 back 2x
- 3 sleeve 2x
- 4 back facing 2x

Interfacing: See shaded area on pattern layout.

Sewing

Gather front:

To gather left side seam edge, first stitch lines of machine basting (longest stitch setting) to each side of the marked seam line, from * to *. Hold bobbin threads and gather fabric along threads until distance between asterisks measures 5 cm (2 ins) long. Knot ends of threads (image 1).

Front neck edge:

Neaten edge of front self-facing. Fold facing to inside and baste to seam allowances of shoulder seams, side seams and armholes (image 2). Do not press fold edge.

Back darts:

Fold each back piece along centre of dart, right side facing in. Pin dart lines together. Stitch, beginning at centre of dart and stitching toward each point. Do not back stitch at points of dart but knot threads securely here. Clip dart at waist level (image 3). Press darts toward centre back.

Invisible zip:

Open the zip and push the coil back with your thumbnail to reveal the seam marking between the tape and the coil. Place the open zip face down on the right fabric side of one slit edge. Place edge of zip tape 5 mm (3/16 in) from edge of seam allowance edge (= width of seam allowance minus 1 cm (3/8 in) tape width). Pin top end of zip tape to edge of seam allowance so that teeth of zip begin at marked neck edge. The bottom end of the zip will extend past the marked end of the slit. Place the presser foot on the zip so that the coil is in the notch to the right of the needle (image 4). Stitch zip in place from the top to the marked end of the slit. Close zip. Place the other zip tape face down on the other slit edge and pin upper end in place with a straight pin (image 5). Open zip again. Place the presser foot on the top end of the zip so that the coil is in the notch to the left of the needle. Sew the zip in place, from the top to the end of the slit (image 6). Close the zip.

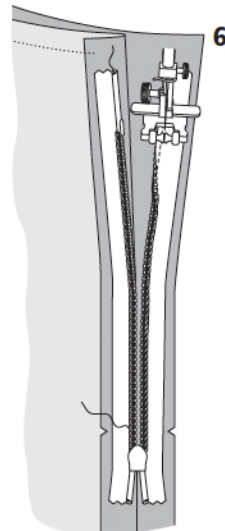
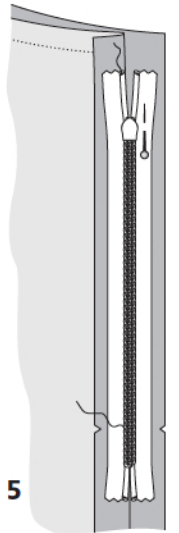
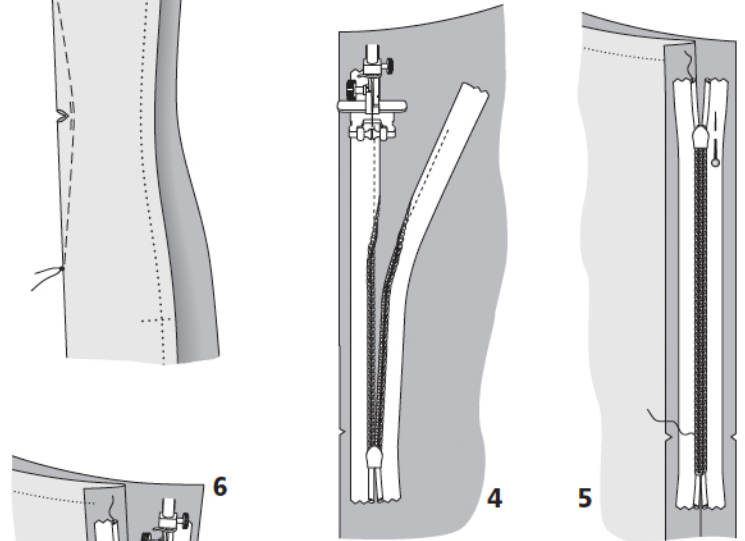
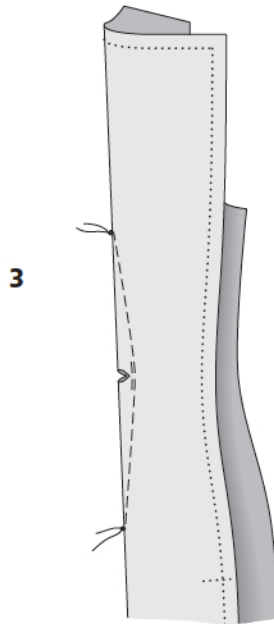
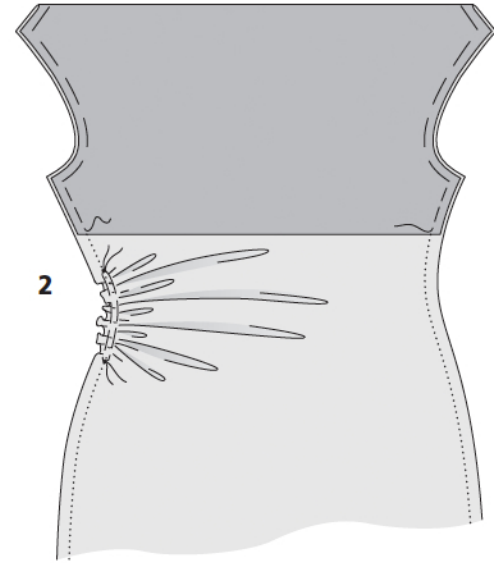
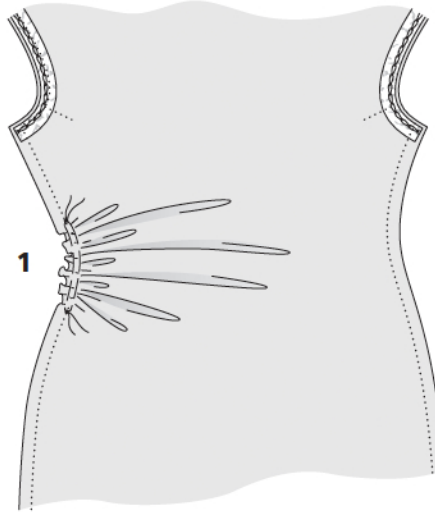

Sewing Continued...**Centre back seam:**

Below zip, lay back pieces together, right sides facing. Pin centre back seam from lower edge to zip, turning loose lower end of zip out of the way, over seam allowances. Stitch seam, using the zipper foot of your sewing machine and ending stitching as close to last stitches of zip seams as possible (image 7). Press seam allowances open and neaten edges.

Back neck edge:

Neaten inside facing edges. Pin each facing piece to back neck edge, right sides together. Fold back facing edges to outside, approx. 5 mm (3/16 in) before marked seam line, and pin to neck edge. On back pieces, turn allowances of back slit edges (with zip halves) to outside and pin to upper edge, over facing (image 8). Stitch along neck edge. Trim seam allowances. Turn allowances of slit edges to inside. Turn facings to inside. Press neck edge. Do not yet sew facings to zip tapes.

Shoulder seams:

On backs, turn neck facings up again. Lay front shoulder edges on back shoulder edges, right sides facing. Pin shoulder seams (image 9). Fold facings over front to outside and pin shoulder edges of facings to shoulder edges of front. Stitch shoulder seams (image 10). Neaten edges of seam allowances together. Pull front down and out and turn back facings to inside again. Press. Sew back facings to zip tapes (image 11)

Side seams:

Lay dress front on dress back, right sides together. Pin side seams, distributing gathering on front evenly. Stitch. Press seam allowances open and neaten edges of allowances.

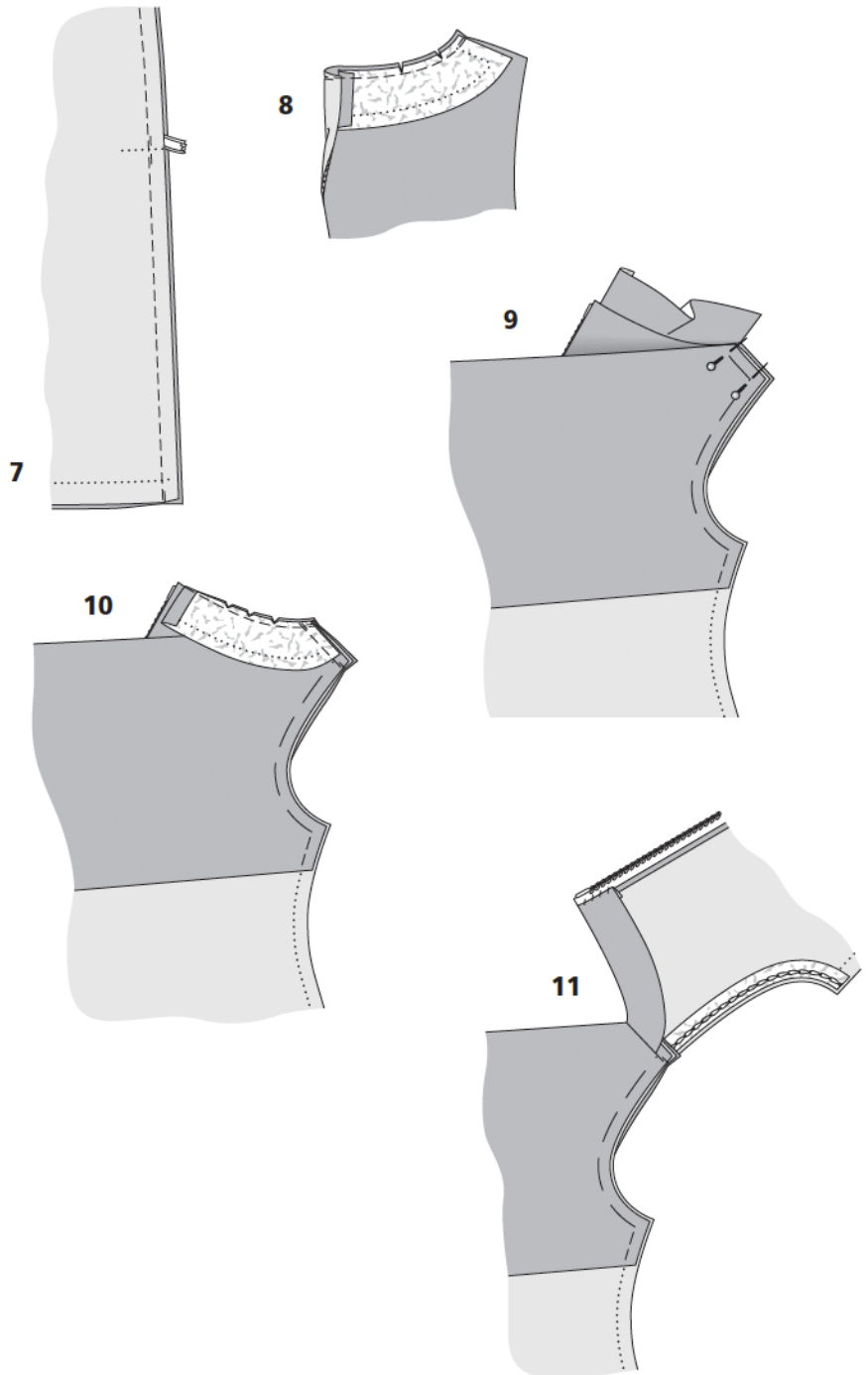

Sewing Continued...

Sleeves:

To ease each sleeve cap, first stitch lines of machine basting (longest stitch setting) to each side of the marked seam line, from • to •. Do not yet pull bobbin threads of this stitching. Fold each sleeve lengthwise, right side facing in. Pin sleeve seam. Stitch. Press seam open and neaten edges of allowances.

Setting in sleeves:

First pin sleeve to underarm curve, right sides facing, matching side seam and sleeve seam and matching seam marks (4) on sleeve and front (image 12). Then pin seam mark on sleeve cap to shoulder seam. Ease fabric of sleeve cap along bobbin threads of ease stitching until of sleeve cap matches armhole edge. Pin remaining sleeve cap in place, distributing eased fullness evenly. Working from sleeve side, baste and stitch sleeve to armhole edge (image 13). Trim seam allowances to 1 cm (3/8 in) wide and neaten edges together. In area of sleeve cap, lay allowances toward sleeves.

Hem, sleeve hems:

Finish edges of hem allowances on dress and sleeves. Press allowances to inside and sew in place loosely by hand.

